



Yale[®]

**Catálogo general
de productos**

**Colombia
2018**



www.YaleColombia.com



ÍNDICE

Index

- **03**
Cerraduras de sobreponer / Rim locks
- **17**
Cerraduras de embutir / Mortise locks
- **37**
Residencial / Residential
- **53**
Candados / Padlocks
- **69**
Institucional / Institutional
- **91**
Digital / Digital
- **117**
Cerraduras eléctricas / Electrical rim locks
- **135**
Cerraduras para mueble y auto / Furniture and auto locks
- **143**
Accesorios / Accessories

CONTACTO

Contact

Síguenos y comunícate con nosotros

Sitio Web / Web site
www.yalecolombia.com

Teléfono / Phone number:
(57 -1) 5962000 Ext. 101

Escríbenos por whatsapp:
 +57 318 365 9422

Facebook
 /YaleLatinoamerica

Instagram
 @Yale_Latinoamerica

YouTube
 /YaleLatinamerica



HISTORIA

History



Linus Yale Sr



Linus Yale Sr

Yale

La historia de la marca Yale comenzó hace más de 140 años con Linus Yale Jr, Ingeniero Mecánico de Estados Unidos; su padre, Linus Yale Sr, mecánico de precisión y dueño del taller Yale.

Linus Yale Jr, continuando los pasos de su padre se convirtió en el experto más importante en cerraduras de su tiempo, diseñando en 1862 la Cerradura para Bancos "Monitor", que marcó la transición de las cerraduras de llaves a las reconocidas cerraduras de combinación para bancos. En 1865 patentó su invento más importante: la cerradura de cilindro de pines. Este sistema es la base de la mayoría de cerraduras de cilindro y en la actualidad es el tipo de cerradura más usada en el mundo.

En 1868 fundó junto con su colega Henry Towne la compañía Yale & Towne Company en Stamford, Connecticut. Después de su fallecimiento, su hijo John B. Yale se unió con Henry Towne para que la compañía creciera convirtiéndose en una gran empresa manufacturera, logrando emplear a más de 12,000 personas y expandirse a los principales países del mundo a principios del siglo 20.

Desde agosto del 2000 la marca Yale forma parte del grupo ASSA ABLOY. Hoy en día Yale es líder en soluciones de seguridad con productos innovadores los cuales nos han permitido tener presencia en más de 125 países incluyendo su gran presencia en Latinoamérica. Las cerraduras, candados y los últimos desarrollos de la marca están siempre presentes en la mente de los usuarios convirtiéndola en la marca más reconocida y favorita del mundo.

Yale

The Yale brand's history starts almost 140 years ago with Linus Yale Jr; his father, Linus Yale Sr, was a highly skilled precision mechanic and owner of Yale Lock Shop.

Linus Yale Jr, wanted to follow his father's steps and became the leading lock expert of his time, introducing the Monitor Bank Lock in 1862, which marked the transition from key-based bank locks to dial or combination ones. But it was on 1865 when he created his most important invention: the cylinder lock. The cylinder lock became a popular style of locking mechanism and today it is the most widely used type of door lock in the world.

Linus Yale Junior and his colleague, Henry Towne, established the Yale & Towne Company in Stamford, Connecticut in 1868. After his death, his son, John B. Yale, joined Henry Towne and helped the company grow from a small shop into a large manufacturing enterprise, employing more than 12,000 employees and expanding into other parts of the world in the early 20th century.

The Yale brand became a part of the ASSA ABLOY Group in August 2000. Nowadays Yale is the leader in security solutions with innovative products that allows us to have presence in more than 125 countries including Latin-America. The locks, padlocks and other security related products are always in the top of mind of the end user, making it the world's favorite lock.



Ref: 987 serie black

CERRADURAS DE SOBREPONER

Rim locks



Las cerraduras de sobreponer Yale son las más conocidas en el sector marcando la pauta en seguridad durante años. Los modelos son diseñados con cilindro de latón macizo y 6 pines que garantizan una alta durabilidad y mayor seguridad. Esto las convierte en sinónimo de calidad y tradición preferidas por los conocedores y especialistas en la materia, por eso son las cerraduras favoritas del mundo.

Yale rim locks are widely known in the market and have set the standards in security for many years. The models are designed with a 6 pins solid brass cylinder that guarantees its high durability and safety. They are known for its quality and tradition, which is why they are the world's favorite lock.

GLOSARIO

Glossary

Características / Features:

 En partes mecánicas On mechanical parts	 Dos llaves Two keys	 Tres llaves Three keys	 Cuatro llaves Four keys
 Cinco llaves Five keys	 Cuatro llaves Four keys	 Backset 50mm 50mm backset	 Backset 60mm 60mm backset
 Backset 70mm 70mm backset	 Triple pasador de 3 golpes Three turns triple bolt	 5 pines 5 pins	 6 pines 6 pins
 7 pines 7 pins			

Abreviatura / Abbreviation:

D: Derecha / Right	H: Caja en hierro / Iron case
I: Izquierda / Left	P: Llave plus / Dimple key
S: Soldar / Weld	F: Cilindro Fijo / Fixed cylinder
C: Corriente / Current	IGU: Igualado / Keyed alike
R: Roseta / Rosette	LI-LI: Llave - llave / Doble cylinder
B: Empaque blister / Visual pack	LI-Ma: Llave mariposa / Thumb turn
A: Cantonera en ángulo / Angled strike	
Z: Cilindro en zamac / Zamak Cylinder	



987 1/4



- Backset de 70mm
 - Para puertas metálicas de 30 a 60mm de espesor
 - Doble bulón de 3 golpes, accionado con la llave por ambos lados
 - Caja y cantonera en acero
- 70mm backset
 - For metal doors with 30 to 60mm in thickness
 - 3 turns double bolt operated by key on both sides
 - Case and strike made of steel

SKU	DESCRIPCIÓN / DESCRIPTION
0003001	Cerr Sobre 987 70 CD
0003002	Cerr Sobre 987 70 CI
0003003	Cerr Sobre 987 70 SD
0003004	Cerr Sobre 987 70 SI
0003103	Cerr Sobre 987 70 SD B
0003104	Cerr Sobre 987 70 SI B

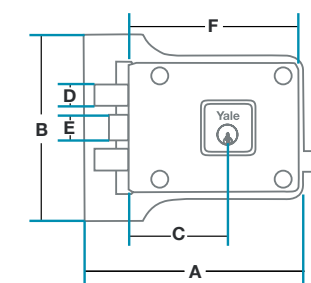

MEDIDAS EN mm. / MEASURES IN mm.					
A	B	C	D	E	F
152,5	130	70	15	18	120

-  x 5
-  70 mm
-  x 4

 GARANTÍA DE POR VIDA

987 Plus



- Backset de 70mm
 - Para puertas metálicas de 30 a 60mm de espesor
 - Cilindro de alta seguridad llave plana con 7 pines dificulta la apertura con ganzúa
 - Doble bulón de 3 golpes, accionado con la llave por ambos lados
 - Caja y cantonera en acero
- 70mm backset
 - For metal doors with 30 to 60mm in thickness
 - High security dimple key cylinder with 7 pins to prevent picking
 - 3 turns double bolt operated by key on both sides
 - Case and strike made of steel

SKU	DESCRIPCIÓN / DESCRIPTION
0003116	Cerr Sobre 987 70 SDP
0003117	Cerr Sobre 987 70 SIP
0003216	Cerr Sobre 987 70 SDP B
0003217	Cerr Sobre 987 70 SIP B

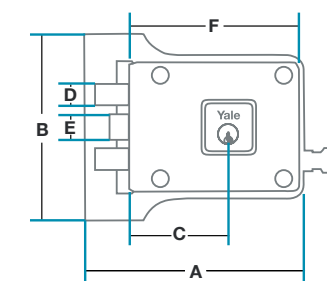

MEDIDAS EN mm. / MEASURES IN mm.					
A	B	C	D	E	F
152,5	130	70	15	18	120

-  70 mm
-  x 4
-  x 7

 GARANTÍA DE POR VIDA





987 SERIE BLACK

- Backset de 70mm
- Para puertas de madera o metálicas de 30 a 60mm de espesor
- Doble bulón de 3 golpes, accionado con la llave por ambos lados
- Caja y cantonera en acero
- 70mm backset
- For wooden or metal doors with 30 to 60mm in thickness
- 3 turns double bolt operated by key on both sides
- Case and strike made of steel

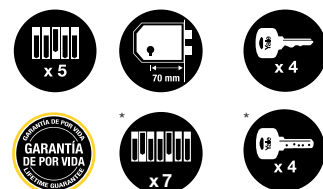

*Exclusivo llave plana / Dimple key exclusive

MEDIDAS EN mm. / MEASURES IN mm.

A	B	C	D	E	F
152,5	130	70	15	18	120

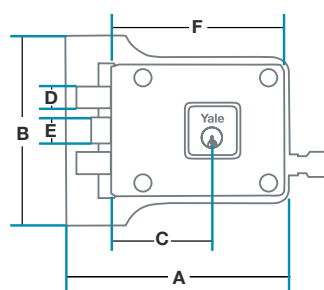

SKU DESCRIPCIÓN / DESCRIPTION

0003009	Cerr Sobre 987 70 SD Black
0003010	Cerr Sobre 987 70 SI Black
0003017	Cerr Sobre 987 70 SDP Black
0003018	Cerr Sobre 987 70 SIP Black

SERIE BLACK



3623-60

- Backset de 60mm
- Para puertas metálicas de 30 a 60mm de espesor
- Cilindros en latón
- Triple pasador de tres golpes, accionado con llave por ambos lados
- Pestillo en latón reversible para puertas de abrir hacia afuera
- Caja, contratapa y cantonera en acero
- Dos (2) llaves
- 60mm backset
- For metal doors, 30 to 60mm thick
- Brass cylinders
- Three turns triple bolt, operated by key on both sides
- Reversible brass latch lever to open doors out swinging
- Steel case, strike and welding steel cover
- Two (2) keys



MEDIDAS EN mm. / MEASURES IN mm.

A	B	C	D	E
120	90	20	60	48

SKU DESCRIPCIÓN / DESCRIPTION

0003320	Cerr sobre 3623 60 SD
0003321	Cerr sobre 3623 60 SI

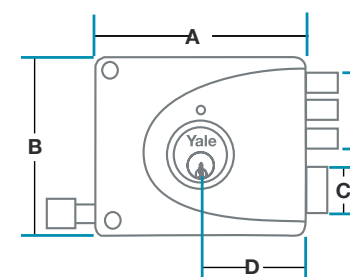

984 1/4

- Backset de 70mm
- Para puertas de madera de 30 a 60mm de espesor
- Cerrojo de 2 golpes, accionado con la llave por ambos lados
- Pestillo tirador reversible para puertas de abrir hacia fuera
- Caja y cantonera en acero
- 70mm backset
- For wooden doors with 30 to 60mm in thickness
- 2 turns bolt operated by key on both sides
- Reversible latch lever to open doors out swinging
- Case and strike made of steel

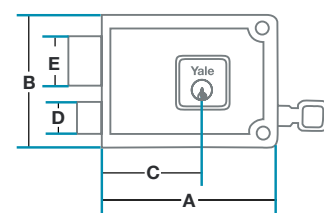
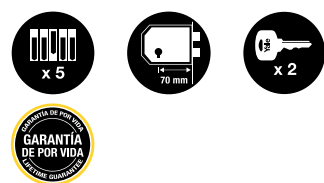

MEDIDAS EN mm. / MEASURES IN mm.

A	B	C	D	E
120	90	70	21,6	33,3

SKU DESCRIPCIÓN / DESCRIPTION

0003011	Cerr Sobre 984 70 CD
0003012	Cerr Sobre 984 70 CI

106-60

- Backset: 60mm
- Cerrojo de tres golpes accionado con la llave por ambos lados
- Caja y cantonera en acero
- Pestillo tirador reversible para puertas de abrir hacia afuera
- Cilindros en latón
- 2 llaves en latón
- 60mm backset
- 3 turns bolt operated by key on both sides
- Case and strike made of steel
- Reversible latch lever to open doors out swinging
- Brass cylinders
- 2 brass keys



Cilindro protegido para mayor seguridad
Covered cylinder for better security

SKU DESCRIPCIÓN / DESCRIPTION

0003042	Sobre acoraz 106 60 CD
0003043	Sobre acoraz 106 60 CI

MEDIDAS EN mm. / MEASURES IN mm.

A	B	C	D	E
120	85	60	20	35

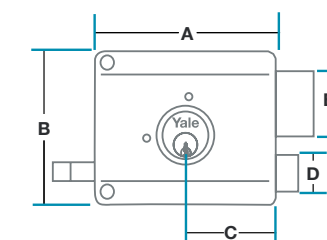



Cilindro protegido para mayor seguridad
Covered cylinder for better security

105-50

- Backset: 50mm
- Cerrojo de tres golpes accionado con la llave por ambos lados
- Cadena, caja y cantonera en acero
- Pestillo tirador reversible para puertas de abrir hacia afuera
- Cilindros en latón
- 2 llaves en latón
- 50mm backset
- 3 turns bolt operated by key on both sides
- Chain, case and strike made of steel
- Reversible latch lever to open doors out swinging
- Brass cylinders
- 2 brass keys

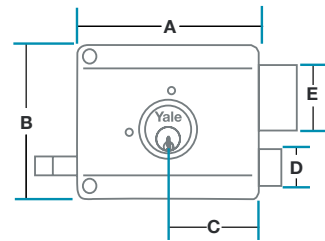

SKU	DESCRIPCIÓN / DESCRIPTION
0003084	Sobre Acoraz 105 50 CD
0003085	Sobre Acoraz 105 50 CI

MEDIDAS EN mm. / MEASURES IN mm.				
A	B	C	D	E
100	85	50	20	35

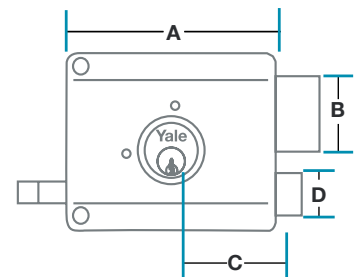

MEDIDAS EN mm. / MEASURES IN mm.			
A	B	C	D
120	33,5	50/60	21,6

SKU	DESCRIPCIÓN / DESCRIPTION
0003046	Cerr Sobre 3610 60 CD
0003047	Cerr Sobre 3610 60 CI
0003060	Cerr Sobre 3610 50 SD*
0003061	Cerr Sobre 3610 50 SI*
0003150	Cerr Sobre 3610 50 SD B*
0003151	Cerr Sobre 3610 50 SI B*
0003197	Cerr Sobre 3610 50 SDZ*
0003198	Cerr Sobre 3610 50 SIZ*
0003054	Cerr Sobre 3610 60 SD*
0003055	Cerr Sobre 3610 60 SI*

* Exclusivo para exportaciones / *Export only

3610

- Backset de 50 o 60mm
- Para puertas de madera o metálicas de 30 a 60mm de espesor
- Cerrojo de 3 golpes, accionado con la llave por ambos lados
- Pestillo tirador reversible para puertas de abrir hacia fuera
- Caja y cantonera en acero
- 50 or 60mm backset
- For wooden or metal doors with 30 to 60mm in thickness
- 3 turns bolt operated by key on both sides
- Reversible latch lever to open doors out swinging
- Case and strike made of steel

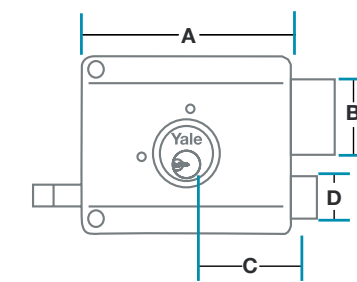

MEDIDAS EN mm. / MEASURES IN mm.			
A	B	C	D
120	33,5	50/60	21,6

SKU	DESCRIPCIÓN / DESCRIPTION
0003076	Cerr Sobre 3610 60 CDP
0003077	Cerr Sobre 3610 60 CIP
0003078	Cerr Sobre 3610 60 CDP B
0003079	Cerr Sobre 3610 60 CIP B



31610

- Backset: 50 o 60mm
- Para puertas de madera o metálicas de 30 a 60mm de espesor
- Cerrojo de 3 golpes, accionado con la llave por ambos lados
- Pestillo tirador reversible para puertas de abrir hacia fuera
- Caja y cantonera en acero
- 50 or 60mm backset
- For wooden or metal doors with 30 to 60mm in thickness
- 3 turns bolt operated by key on both sides
- Reversible latch lever to open doors out swinging
- Case and strike made of steel



3610 Plus

- Backset de 60mm
- Para puertas de madera o metálicas de 30 a 60mm de espesor
- Cilindro de alta seguridad llave plana dificulta la apertura con ganzúa
- Cerrojo de 3 golpes, accionado con la llave por ambos lados
- Pestillo tirador reversible para puertas de abrir hacia fuera
- 4 llaves planas multipunto
- Caja y cantonera en acero
- 60mm backset
- For wooden or metal doors with 30 to 60mm in thickness
- High security dimple key cylinder to prevent picking
- 3 turns bolt operated by key on both sides
- Reversible latch lever to open doors out swinging
- 4 dimple keys
- Case and strike made of steel

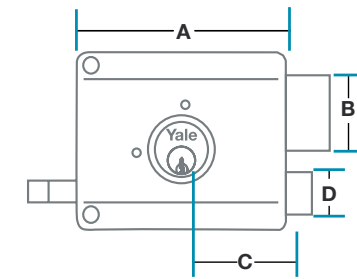
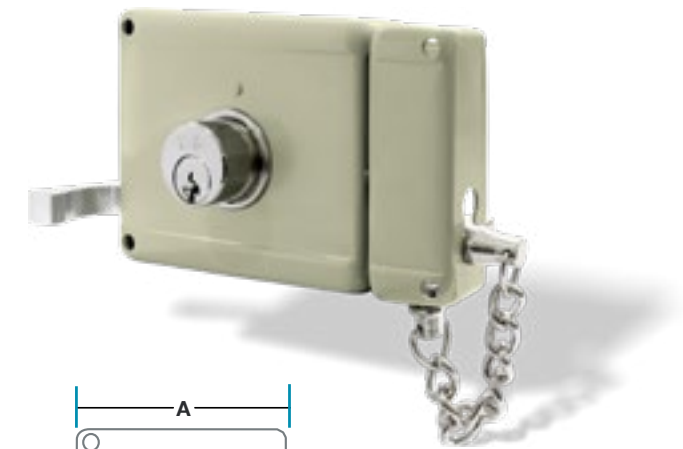

MEDIDAS EN mm. / MEASURES IN mm.			
A	B	C	D
100	35,6	50/60	20

SKU	DESCRIPCIÓN / DESCRIPTION
0003070	Cerr Sobre 3610 50 CD
0003071	Cerr Sobre 3610 50 CI
0003133	Cerr Sobre 3610 50 CD B
0003134	Cerr Sobre 3610 50 CI B
0003052	Cerr Sobre 3610 50 SD*
0003053	Cerr Sobre 3610 50 SI*
0003182	Cerr Sobre 3610 60 SD*
0003183	Cerr Sobre 3610 60 SI*

* Exclusivo para exportaciones / *Export only

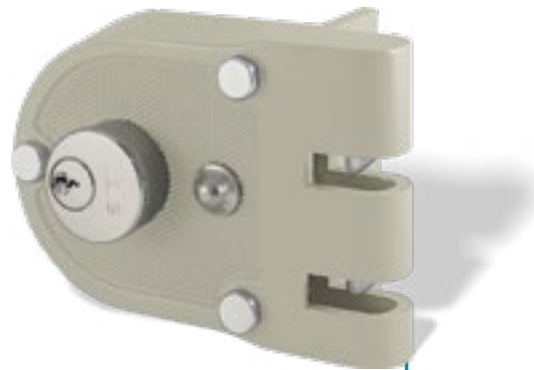

396 1/4

- Backset de 60mm
- Para puertas que abren hacia adentro o corredizas de 30 a 60mm de espesor
- Doble pestillo vertical de 6mm en acero forjado y zincado
- Mayor seguridad mediante giro del cilindro con el uso de la llave
- Al usar el botón de retén, los pestillos se bloquean en la posición de arriba
- Contratapa y cantonera plana en acero para soldar
- 60mm backset
- For inward opening doors or sliding doors of 30 to 60mm in thickness
- 6mm double vertical bolts forged steel
- Increased security with turn of cylinder
- Using detent button, the latches stop working
- Strike and welding steel cover

MEDIDAS EN mm. / MEASURES IN mm.

A	B	C	D	E	F
120,6	28	60	22,5	9,5	42,3

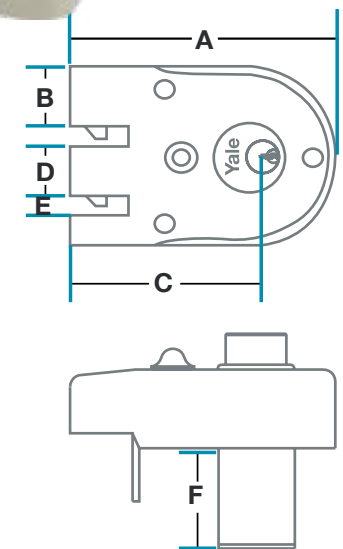

*Exclusivo para exportaciones / *Export only

SKU	DESCRIPCIÓN / DESCRIPTION
0003021	Cerr Sobre 396 60 SD
0003022	Cerr Sobre 396 60 SI
0003086	Cerr Sobre 396 60 SDA*
0003087	Cerr Sobre 396 60 SIA*
0003088	Cerr Sobre 396 60 SDAB*
0003089	Cerr Sobre 396 60 SIAB*
0003029	Cerr Sobre 396 60 SDF*
0003030	Cerr Sobre 396 60 SIF*

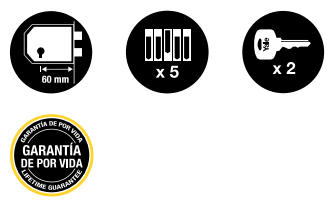

396 Roseta

- Backset de 60mm
- Para puertas que abren hacia adentro o corredizas de 30 a 60mm de espesor
- Doble pestillo vertical de 6mm en acero forjado y zincado
- Los pestillos se accionan mediante giro de la roseta interior y con la llave por ambos lados
- El botón de retén bloquea los pestillos en la posición de arriba
- Contratapa y cantonera plana en acero para soldar
- 60mm backset
- For inward opening doors or sliding doors of 30 to 60mm in thickness
- 6mm double vertical bolts forged steel
- The latch is activated by rotating the inner rosette or with a key
- Using detent button, the latches stop working
- Strike and welding steel cover

MEDIDAS EN mm. / MEASURES IN mm.

A	B	C	D	E	F
120,6	28	60	22,5	9,5	42,3

SKU	DESCRIPCIÓN / DESCRIPTION
0003023	Cerr Sobre 396 60 CDR
0003024	Cerr Sobre 396 60 CIR
0003025	Cerr Sobre 396 60 SDR
0003026	Cerr Sobre 396 60 SIR
0003125	Cerr Sobre 396 60 SDRB
0003126	Cerr Sobre 396 60 SIR B
0003096	Cerr Sobre 396 60 SDRA*
0003097	Cerr Sobre 396 60 SIRA*
0003098	Cerr Sobre 396 60 SDRA B*
0003099	Cerr Sobre 396 60 SIRA B*
0003129	Cerr Sobre 396 60 SDRF B*
0003130	Cerr Sobre 396 60 SIRF B*

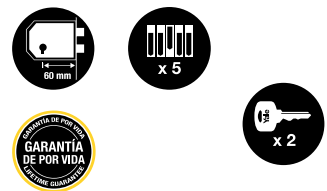
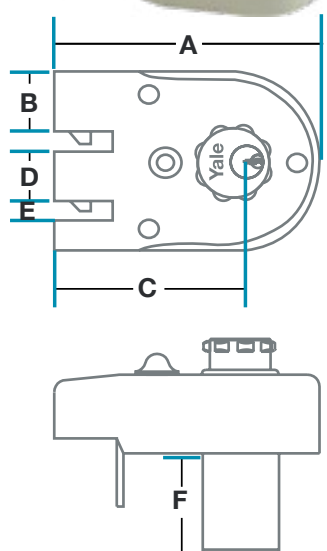

*Exclusivo para exportaciones / *Export only



396 SERIE BLACK

- Backset de 60mm
- Para puertas que abren hacia adentro o corredizas de 30 a 60mm de espesor
- Doble pestillo vertical de 6mm en acero forjado y zincado
- Los pestillos se accionan mediante giro de la roseta interior y con la llave por ambos lados
- El botón de retén bloquea los pestillos en la posición de arriba
- Contratapa y cantonera plana en acero para soldar
- 60mm backset
- For inward opening doors or sliding doors of 30 to 60mm in thickness
- 6mm double vertical bolts forged steel
- The latch is activated by rotating the inner rosette or with a key
- Using detent button, the latches stop working
- Strike and welding steel cover

MEDIDAS EN mm. / MEASURES IN mm.

A	B	C	D	E
120,6	28	60	22,5	9,5

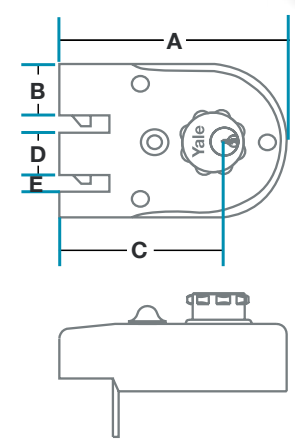

SKU	DESCRIPCIÓN / DESCRIPTION
0003031	Cer sobr 396 60 SDR Black
0003032	Cer sobr 396 60 SIR Black
0003019	Cer sob 396 60 SDRP Black
0003020	Cer sob 396 60 SIRP Black

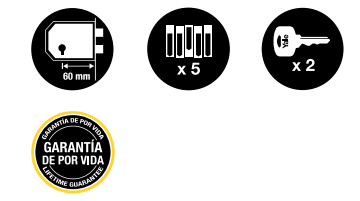

396 Plus

- Backset de 60mm
- Para puertas que abren hacia adentro o corredizas
- 30 a 60mm de espesor
- Doble pestillo vertical de 6mm en acero forjado y zincado
- Los pestillos se accionan mediante giro de la roseta interior y con la llave por ambos lados
- El botón de retén bloquea los pestillos en la posición de arriba
- Cilindro de alta seguridad llave plana dificulta la apertura con ganzúa
- 4 llaves planas reversibles multipunto
- Contratapa y cantonera plana en acero para soldar
- 60mm backset
- For inward opening doors or sliding doors of 30 to 60mm in thickness
- 6mm double vertical bolts forged steel
- The latch is activated by rotating the inner rosette or with a key
- Using detent button, the latches stop working
- High security dimple key cylinder to prevent picking
- 4 reversible dimple keys
- Strike and welding steel cover

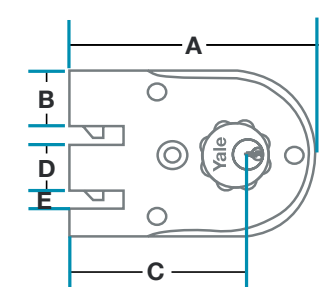

SKU	DESCRIPCIÓN / DESCRIPTION
0003037	Cerr Sobre 396 60 SDRP
0003038	Cerr Sobre 396 60 SIRP
0003039	Cerr Sobre 396 60 SDRPB
0003040	Cerr Sobre 396 60 SIRPB

MEDIDAS EN mm. / MEASURES IN mm.

A	B	C	D	E
120,6	28	60	22,5	9,5



396 H

- Backset de 60mm
- Para puertas que abren hacia adentro o corredizas de 30 a 60mm de espesor
- Doble pestillo vertical de 6mm en acero forjado y zincado
- Los pestillos se accionan mediante giro de la roseta interior y con la llave por ambos lados
- El botón de retén bloquea los pestillos en la posición de arriba
- Cantonera plana en acero para soldar
- 60mm backset
- For inward opening doors or sliding doors of 30 to 60mm in thickness
- 6mm double vertical bolts forged steel
- The latch is activated by rotating the inner rosette or with a key
- Using detent button, the latches stop working
- Welding steel strike

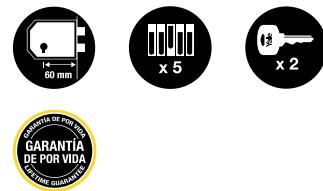
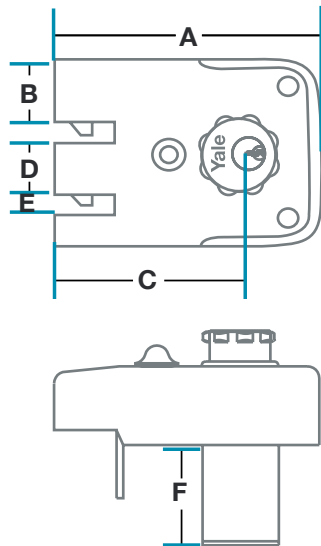

* Exclusivo para exportaciones / *Export only

MEDIDAS EN mm. / MEASURES IN mm.					
A	B	C	D	E	F
120,6	28	60	22,5	9,5	42,3

SKU	DESCRIPCIÓN / DESCRIPTION
0003173	Cerr Sobre 396 60 SDRHF B*
0003174	Cerr Sobre 396 60 SIRHF B*

OF5M

- Backset de 60mm
- Picaporte con cilindro
- El pestillo puede bloquearse con el botón retenedor
- Pestillo reversible
- 60mm backset
- Latch bolt with cylinder
- Can be locked with the button
- Reversible latch



MEDIDAS EN mm. / MEASURES IN mm.		
A	B	C
90	25	60

SKU	DESCRIPCIÓN / DESCRIPTION
0003051	Cerr Sobre OF5 60 C

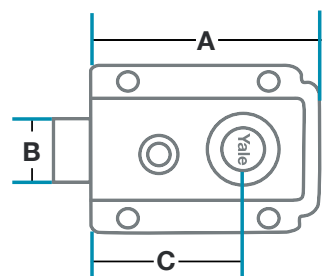

LOS MATERIALES DE NUESTROS PRODUCTOS LOS HACEN SUPERIORES

Cilindro: El cilindro es el componente que brinda la seguridad en cualquier tipo de cerradura, y en las cerraduras de sobreponer no es la excepción. Los cilindros de las cerraduras de sobreponer Yale son elaborados en latón, material que nos ubica por encima de otros productos similares del mercado en términos de duración, resistencia y seguridad. Además nuestros cilindros son macizos (*excepto en las referencias 105 y 106*), protegiendo las piezas internas del mismo, dando un gran valor agregado en términos de seguridad comparado con otras cerraduras del mercado que tienen cilindros aligerados.

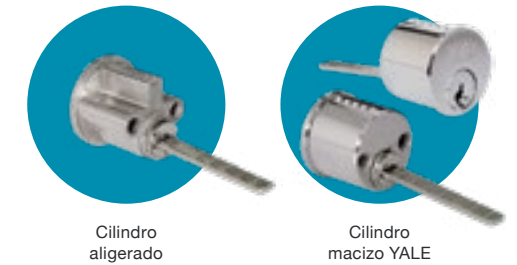

Bulones o pasadores: Los bulones de las cerraduras de sobreponer Yale están diseñados con los materiales adecuados para brindar alta seguridad, resistencia y larga vida útil. Al ser fabricados en acero con un baño que los hace tener mayor resistencia a la corrosión o Zamac de alta dureza, son la mejor opción para mantener seguro lo que mas quieres.



Pestillo resbalón: al igual que los cilindros, la cabeza del pestillo resbalón de las cerraduras de sobreponer Yale son fabricados en Latón, haciendo que esta pieza sea mucho más duradera y resistente, teniendo en cuenta la fricción continua a la que es sometida esta pieza, logrando así un mayor rendimiento en seguridad y vida útil de nuestros productos.

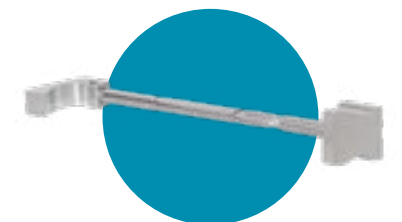

Por estas y muchas otras razones, Yale es la mejor opción en cerraduras de **sobreponer.**



Cuerpo interior del cilindro en latón para **mayor seguridad y duración**



2250 - 2250 cilindro fijo / 2250 - 2250 fixed cylinder

- Backset de 50mm
 - Pestillo reversible para puertas de abrir hacia afuera
 - Triple pasador de tres golpes, accionado con llave por ambos lados
 - Bloquea el pestillo resbalón con el tercer golpe de los pasadores
 - Para puertas de 30 a 60mm de espesor
- 50mm Backset
 - Reversible latch lever to open doors out swinging
 - Three turns triple bolt, operated by key on both sides
 - Locks the latch with third turn of the key
 - 30 to 60mm thick doors

SKU	DESCRIPCIÓN / DESCRIPTION
0012140	Cerr Sobre PHI 2250 CD
0012141	Cerr Sobre PHI 2250 CI
0012145	Cerr Sobre PHI 2250 CD CF
0012146	Cerr Sobre PHI 2250 CI CF

También disponible con cilindro fijo de 42mm
Also Available with fixed cylinder 42mm



650

- Backset de 50mm
 - Pestillo reversible para puertas de abrir hacia afuera
 - Cerrojo de tres golpes, accionado con llave por ambos lados
 - Bloquea el pestillo resbalón con el tercer golpe de los pasadores
 - Para puertas de 30 a 60mm de espesor
- 50mm Backset
 - Reversible latch lever to open doors out swinging
 - 3 turns bolt operated by key on both sides
 - Locks the latch with third turn of the key
 - 30 to 60mm thick doors



SKU	DESCRIPCIÓN / DESCRIPTION
0012142	Cerr Sobre PHI 650 CD
0012143	Cerr Sobre PHI 650 CI



4160

- Backset de 60mm
 - Doble pestillo vertical
 - Los pestillos se accionan con la llave por ambos lados
 - Al usar el botón de retén, los pestillos se bloquean en la posición de arriba
 - Para puertas de 30 a 60mm de espesor
- 60mm Backset
 - Double vertical bolts
 - Latch operated by key on both sides
 - Using detent button, the latches stop working
 - For 30 to 60mm thick doors

SKU	DESCRIPCIÓN / DESCRIPTION
0012162	Cerr Sobre PHI 4160 SD
0012163	Cerr Sobre PHI 4160 SI

4060

- Backset de 60mm
 - Doble pestillo vertical
 - Los pestillos se accionan mediante el giro de la roseta interior y con la llave por ambos lados
 - Al usar el botón de retén, los pestillos se bloquean en la posición de arriba
 - Para puertas de 30 a 60mm de espesor
- 60mm Backset
 - Double vertical bolts
 - The latch is activated by rotating the inner rosette or with a key
 - Using detent button, the latches stop working
 - For 30 to 60mm thick doors



SKU	DESCRIPCIÓN / DESCRIPTION
0012160	Cerr Sobre PHI 4060 SDR
0012161	Cerr Sobre PHI 4060 SIR





Toda una historia protegiendo los **hogares Colombianos**

Calle colonial, Cartagena de Indias



Ref. Combo Bari 4 bulones

**CERRADURAS
DE EMBUTIR**
Mortise locks



Yale ofrece el portafolio más completo en cerraduras de embutir con productos diseñados para el sector residencial e institucional ligero con aplicaciones para puertas de madera, metálicas y perfiles de aluminio garantizando la mejor seguridad.

Nuestra nueva línea cuenta con diferentes y nuevos productos; una placa en acero inoxidable que brinda alta durabilidad, variedad en cilindros y nuevos diseños de manijas que hacen posible personalizar la cerradura según tu estilo.

Yale offers a complete portfolio of mortise locks designed to fit different residential and light commercial applications in aluminum, wood or steel doors, ensuring always greater security.

Our new portfolio of products include a stainless steel face plate, a variety of cylinder functions, and new lever designs and trims that make possible to customize the lock according to your style.

GLOSARIO

Glossary

Acabados / Finishes:



AI
Acero inoxidable / Stainless steel



US15
Niquel satinado / Satin nickel



US26D
Cromo satinado / Satin chrome



US26
Cromo brillante / Bright chrome



US3
Latón brillante / Bright brass



Caoba / Brown



Aluminio Natural / Natural Aluminium



US5
Latón antiguo / Antique brass



Negro / Black



Blanco / White



Anoloc / Anoloc

Características / Features:



Backset 15,5mm
15,5mm backset



Backset 20mm
20mm backset



Backset 25mm
25mm backset



Backset 35mm
35mm backset



Backset 45mm
45mm backset



Backset 50mm
50mm backset

Abreviatura / Abbreviation:

S: Sencilla / single

D: Doble / Double

Embut: Embutir / Mortise

LI-LI: Llave -Llave / Double cylinder

LI-Ma: Llave -Mariposa / Thumb turn

LI-C: Llave - Ciega / Single cylinder

R: (Roseta/Placa) Redonda / Round (Rosette/Plate)

C: (Roseta/Placa) Cuadrada / Square (Rosette/Plate)

Esc: Escudo antiladro / Security rosette

***E:** Exterior. Manija fija en el exterior y movable en el interior / E: Exterior. Fixed lever on the outside and active lever inside

***I:** Interior. Ambas manijas son movibles / I: Interior. Both levers are active



SKU	DESCRIPCIÓN / DESCRIPTION
0007088	Embut A24 Natura G LI LI
0007089	Embut A24 Natura G LM
0007090	Embut A24 Natura G LI C
0007091	Embut A28 Natura G LI LI
0007092	Embut A28 Natura G LM
0007093	Embut A28 Natura G LI C
0007094	Embut A24 Anoloc G LI LI
0007095	Embut A24 Anoloc G LM
0007096	Embut A24 Anoloc G LI C
0007097	Embut A28 Anoloc G LI LI
0007098	Embut A28 Anoloc G LM
0007099	Embut A28 Anoloc G LI C
0007151	Embut A28 Negro G LI C
0007152	Embut A28 Negro G LM
0007153	Embut A28 Negro G LI LI
0007150	Embut A28 Blanco G LM
0007154	Embut A28 Blanco G LI LI
0007155	Embut A28 Blanco G LI C

MEDIDAS EN mm. / MEASURES IN mm.						
	A	B	C	D	E	F
24	38,4	173	24	24	151	32
28	42,8	173	28	24	151	32

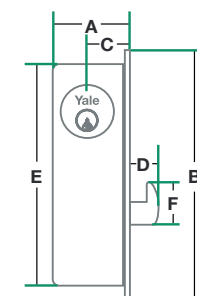

Serie A puertas corredizas / A series for sliding doors

- Ideal para puertas en perfil de aluminio Monumental (Sistema 7038).
- Disponible en backset 1 1/8" (28,6mm) y 31/32" (24,6mm).
- Cuerpo, placa frontal fija y cerrojo en acero.
- **Disponibilidad:** Llave-Llave, Llave-Mariposa y Llave-Ciega.
- **Cilindro:** 5 pines y 2 llaves.
- Ideal for Monumental aluminium profile doors (7038 system)
- Backset: 1 1/8" (28,6mm) and 31/32" (24,6mm)
- Steel body, fixed front plate and deadbolt
- Available in Double cylinder, Thumb turn and single cylinder
- Cylinder: 5 pins 2 keys

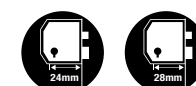

Serie A puertas batientes / A series for swinging doors

- Ideal para puertas en perfil de aluminio Monumental (Sistema 7038).
- Disponible en backset 1 1/8" (28,6mm) y 31/32" (24,6mm).
- Cuerpo, placa frontal fija y cerrojo en acero.
- **Disponibilidad:** Llave-Llave, Llave-Mariposa y Llave-Ciega.
- **Cilindro:** 5 pines y 2 llaves.
- Ideal for Monumental aluminium profile doors (7038 system)
- Backset: 1 1/8" (28,6mm) and 31/32" (24,6mm)
- Steel body, fixed front plate and deadbolt
- Available in Double cylinder, Thumb turn and single cylinder
- Cylinder: 5 pins 2 keys

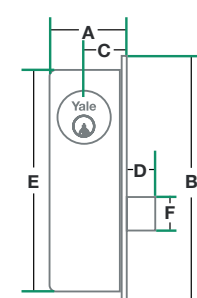
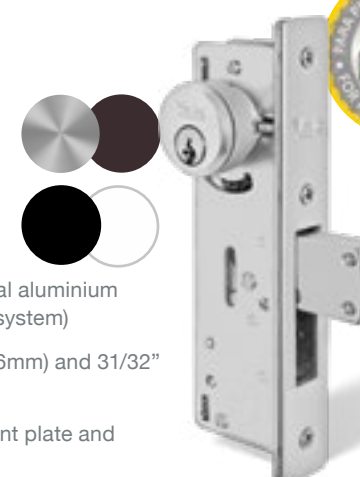
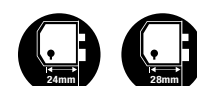

SKU	DESCRIPCIÓN / DESCRIPTION
0007076	Embut A24 Natura M LI LI
0007077	Embut A24 Natura M LM
0007078	Embut A24 Natura M LI C
0007079	Embut A28 Natura M LI LI
0007080	Embut A28 Natura M LM
0007081	Embut A28 Natura M LI C
0007082	Embut A24 Anoloc M LI LI
0007083	Embut A24 Anoloc M LM
0007084	Embut A24 Anoloc M LI C
0007085	Embut A28 Anoloc M LI LI
0007086	Embut A28 Anoloc M LM
0007087	Embut A28 Anoloc M LI C

MEDIDAS EN mm. / MEASURES IN mm.						
	A	B	C	D	E	F
24	38,4	173	24	37,5	151	34,5
28	42,8	173	28	37,5	151	34,5

L370 Clásica / L370 Classic

- Backset de 45mm
- Para puertas de 30 a 60mm de espesor
- Pestillo accionado por el exterior por la llave y por el interior con la manija
- Cerrojo accionado con la llave por ambos lados
- Pestillo reversible para puertas de abrir hacia afuera
- 45mm backset
- For doors 30 to 60mm thick
- Latch activated by key from the outside and by the lever from the inside
- Deadbolt activated by the key on both sides
- Reversible latch for doors opening to the inside or outside



SKU	DESCRIPCIÓN / DESCRIPTION
0004003	Embut L370 Clásica Caoba
0004004	Embut L370 Clásica US26
0004006	Embut L370 Clásica US3
0004101	Embut L370 Clásica US26B
0004102	Embut L370 Clásica US3 B

MEDIDAS EN mm. / MEASURES IN mm.													
A	B	C	D	E	F	G	H	I	J	K	L	M	N
56	222	24	31,7	12	28	35	45	75	68	133	180	200	22

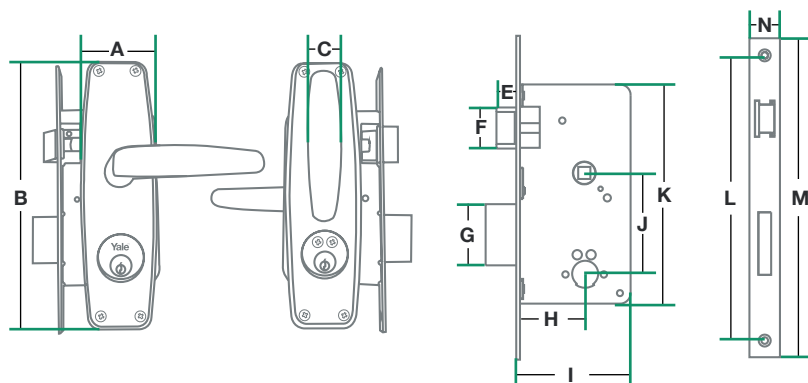

L370 Lisboa

- Backset de 45mm
- Para puertas de 30 a 60mm de espesor
- Pestillo accionado por el exterior por la llave y por el interior con la manija
- Cerrojo accionado con la llave por ambos lados
- Pestillo reversible para puertas de abrir hacia afuera
- 45mm backset
- For doors 30 to 60mm thick
- Latch activated by key from the outside and by the lever from the inside
- Deadbolt activated by the key on both sides
- Reversible latch for doors opening to the inside or outside

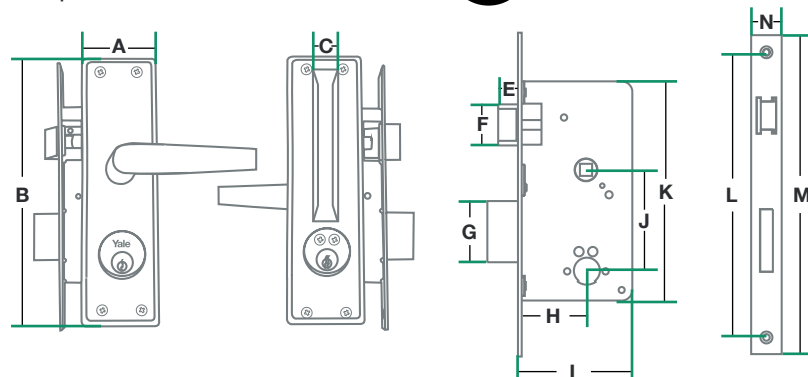

MEDIDAS EN mm. / MEASURES IN mm.													
A	B	C	D	E	F	G	H	I	J	K	L	M	N
23	240	17	31,7	12	28	35	45	75	68	133	180	200	22

SKU	DESCRIPCIÓN / DESCRIPTION
0004007	Embut L370 Lisboa US26D
0004008	Embut L370 Lisboa US15

Serie E Cassette / E series Cassette

- Backset de 20, 25 y 35mm
- Pestillo reversible para puertas de abrir hacia afuera
- Backset: 20, 25 and 35mm
- Reversible latch for doors opening to the outside

MEDIDAS EN mm. / MEASURES IN mm.										
	A	B	C	D	E	F	G	H	I	J
E20	12	27	35	20	35	85	176	210	240	23
E25	12	27	40	25	41	85	176	210	240	23
E35	12	27	47	35	61,5	85	176	210	240	23

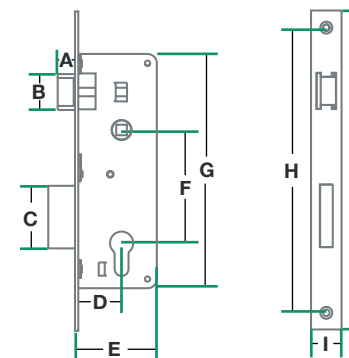

SKU	DESCRIPCIÓN / DESCRIPTION
0004127	Embut E20
0004128	Embut E25
0004129	Embut E35

Serie E Cassette + Cilindro / E series Cassette + Cylinder

- Backset de 20, 25 y 35mm
- Para puertas de 30 a 42mm de espesor
- Pestillo y cerrojo accionado con la llave
- Pestillo reversible para puertas de abrir hacia afuera
- Backset: 20, 25 and 35mm
- For doors 30 to 42mm thick
- Latch and deadbolt activated by key
- Reversible latch for doors opening to the outside

SKU	DESCRIPCIÓN / DESCRIPTION
0004155	Embut E20 + Cil LI LI
0004154	Embut E25 + Cil LI LI
0004156	Embut E35 + Cil LI LI

MEDIDAS EN mm. / MEASURES IN mm.										
	A	B	C	D	E	F	G	H	I	J
E20	12	27	35	20	35	85	176	210	240	23
E25	12	27	40	25	41	85	176	210	240	23
E35	12	27	47	35	61,5	85	176	210	240	23

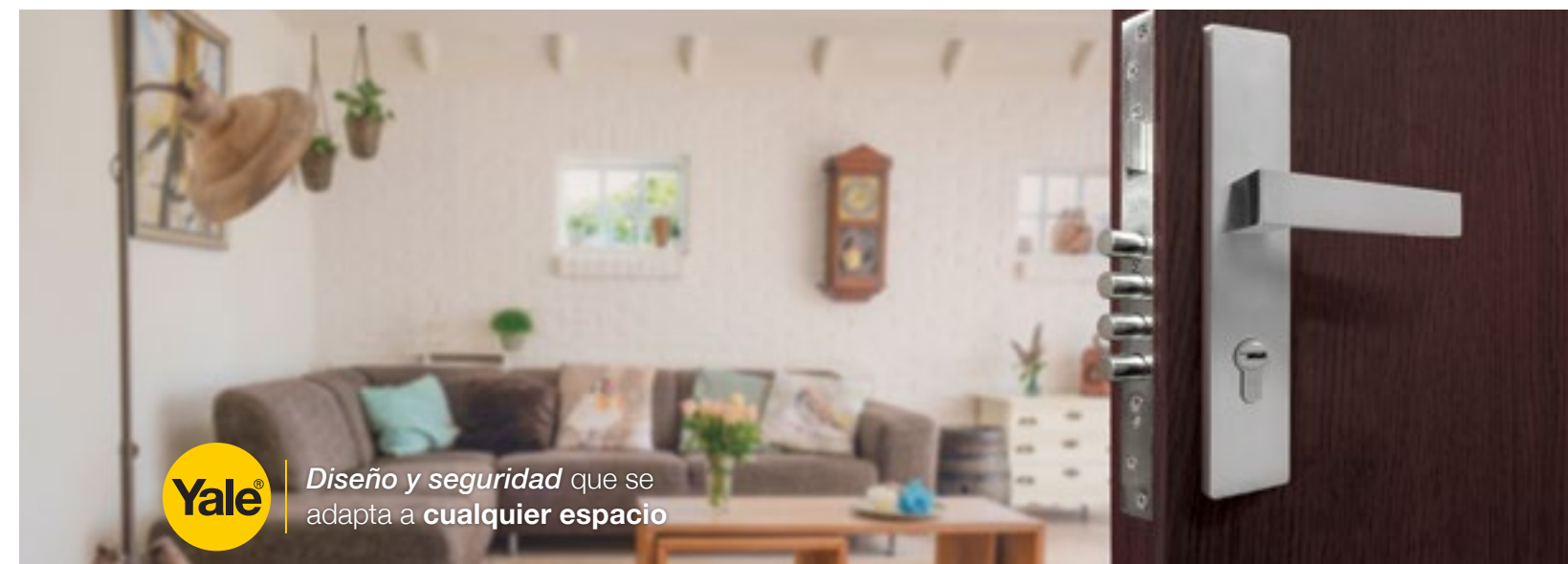
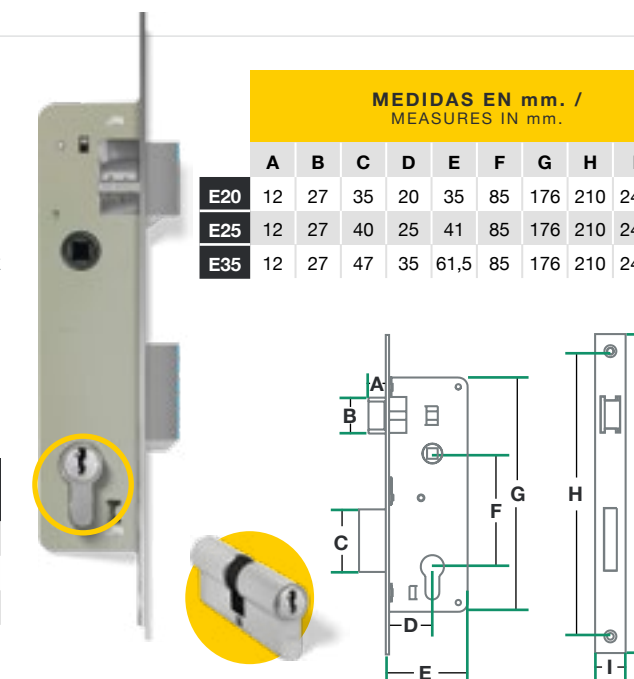

Serie E Clásica / E Series Classic

- Backset 20, 25, 35 y 45mm
- Para puertas de 30 a 42mm de espesor
- Pestillo y cerrojo accionado con la llave
- Pestillo reversible para puertas de abrir hacia afuera
- Disponible con manijas para puertas interiores o exteriores
- Disponible con cilindro llave - llave y llave-mariposa
- 20, 25, 35 and 45mm backset
- For doors 30 to 42mm thick
- Deadbolt and latch activated by the key
- Reversible latch for out swinging doors
- Available with levers for interior or exterior doors
- Available in single and double cylinder

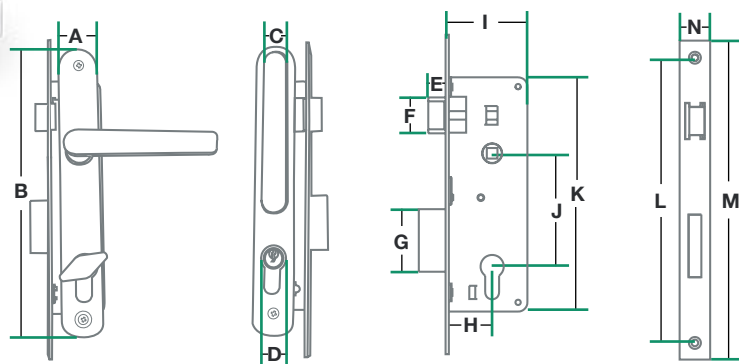

		MEDIDAS EN mm. / MEASURES IN mm.													
		A	B	C	D	E	F	G	H	I	J	K	L	M	N
E20		30	220	18	17	12	27	35	20	35	85	176	210	240	23
E25		30	220	18	17	12	27	40	25	41	85	176	210	240	23
E35		30	220	18	17	12	27	47	35	61,5	85	176	210	240	23
E45		30	220	18	17	12	27	43	45	71	85	176	210	240	23

E20

SKU	DESCRIPCIÓN / DESCRIPTION
0004071	Embut E20 Clásica US26D E
0004070	Embut E20 Clásica US26D I
0004072	Embut E20 Clásica US26D E LM
0004194	Embut E20 Clásica US26D I LM
0004146	Embut E20 Clásica Blanco E
0004144	Embut E20 Clásica Blanco I
0004139	Embut E20 Clásica Blanco E LM
0004181	Embut E20 Clásica Blanco I LM
0004131	Embut E20 Clásica Negro E
0004138	Embut E20 Clásica Negro I
0004133	Embut E20 Clásica Negro E LM
0004182	Embut E20 Clásica Negro I LM
0004076	Embut E20 Clásica US26D E B

E25

SKU	DESCRIPCIÓN / DESCRIPTION
0004060	Embut E25 Clásica US26D E
0004061	Embut E25 Clásica US26D I
0004065	Embut E25 Clásica US26D E LM
0004206	Embut E25 Clásica US26D I LM
0004140	Embut E25 Clásica Blanco E
0004147	Embut E25 Clásica Blanco I
0004142	Embut E25 Clásica Blanco E LM
0004177	Embut E25 Clásica Blanco I LM
0004134	Embut E25 Clásica Negro E
0004132	Embut E25 Clásica Negro I
0004136	Embut E25 Clásica Negro E LM
0004178	Embut E25 Clásica Negro I LM
0004078	Embut E25 Clásica US26D E B

E35

SKU	DESCRIPCIÓN / DESCRIPTION
0004062	Embut E35 Clásica US26D E
0004063	Embut E35 Clásica US26D I
0004064	Embut E35 US26D Clásica E LM
0004201	Embut E35 US26D Clásica I LM
0004143	Embut E35 Clásica Blanco E
0004141	Embut E35 Clásica Blanco I
0004145	Embut E35 Clásica Blanco E LM
0004180	Embut E35 Clásica Blanco I LM
0004137	Embut E35 Clásica Negro E
0004135	Embut E35 Clásica Negro I
0004130	Embut E35 Clásica Negro E LM
0004179	Embut E35 Clásica Negro I LM
0004077	Embut E35 Clásica US26D E B

E45

SKU	DESCRIPCIÓN / DESCRIPTION
0004190	Embut E45 Clásica US26D E
0004192	Embut E45 Clásica US26D I
0004191	Embut E45 Clásica US26D E LM
0004193	Embut E45 Clásica US26D I LM

Serie E Fontana / E Series Fontana

- Backset 20, 25, 35 y 45mm
- Para puertas de 30 a 42mm de espesor
- Pestillo y cerrojo accionado con la llave
- Pestillo reversible para puertas de abrir hacia afuera
- Disponible con manijas para puertas interiores y exteriores
- Disponible con cilindro llave-llave y llave-mariposa
- 20, 25, 35 and 45mm backset
- For doors 30 to 42mm thick
- Latch and deadbolt activated by key
- Reversible latch for doors opening to the inside or outside
- Available with levers for interior and exterior doors
- Available with single and double cylinder



		MEDIDAS EN mm. / MEASURES IN mm.													
		A	B	C	D	E	F	G	H	I	J	K	L	M	N
20		32,5	218	31,5	17	12	27	35	20	35	85	176	210	240	23
25		32,5	218	31,5	17	12	27	40	25	41	85	176	210	240	23
35		32,5	218	31,5	17	12	27	47	35	61,5	85	176	210	240	23
45		32,5	218	31,5	17	12	27	43	45	71	85	176	210	240	23

E20

SKU	DESCRIPCIÓN / DESCRIPTION
0004195	Embut E20 Fontana US15 E
0004199	Embut E20 Fontana US15 I
0004200	Embut E20 Fontana US15 E LM
0004204	Embut E20 Fontana US15 I LM

E25

SKU	DESCRIPCIÓN / DESCRIPTION
0004066	Embut E25 Fontana US15 E
0004198	Embut E25 Fontana US15 I
0004203	Embut E25 Fontana US15 E LM
0004196	Embut E25 Fontana US15 I LM

E35

SKU	DESCRIPCIÓN / DESCRIPTION
0004067	Embut E35 Fontana US15 E
0004205	Embut E35 Fontana US15 I
0004202	Embut E35 Fontana US15 E LM
0004197	Embut E35 Fontana US15 I LM

E45

SKU	DESCRIPCIÓN / DESCRIPTION
0004068	Embut E45 Fontana US15 E
0004059	Embut E45 Fontana US15 I
0004069	Embut E45 Fontana US15 E LM
0004079	Embut E45 Font US15 I LM

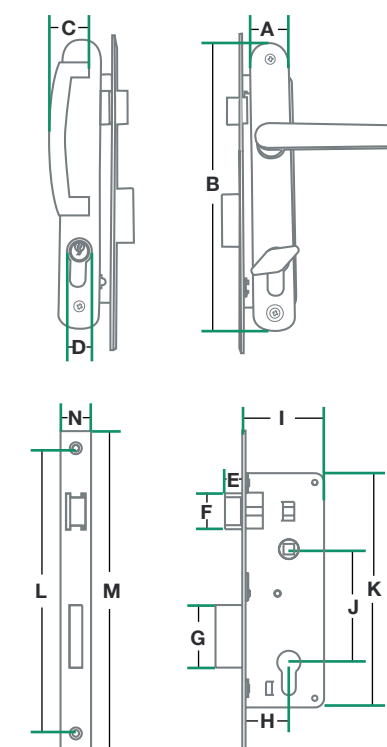

Serie E Mini / E Series Mini



- Ideal para puertas en perfil de aluminio
- Disponible en backset 21mm
- Cilindro interior en acero con 5 pines
- 2 llaves

- Ideal for aluminium profile doors
- Available in 21mm backset
- Steel interior cylinder with 5 pins
- 2 keys

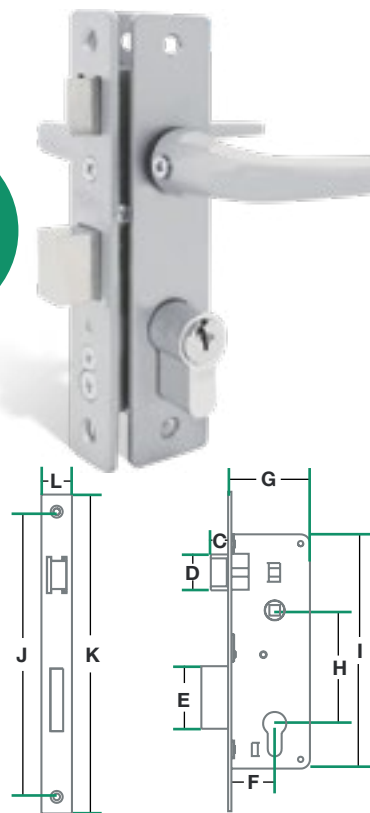

MEDIDAS EN mm. / MEASURES IN mm.											
A	B	C	D	E	F	G	H	I	J	K	L
29	146	10	18	22	21	40	53	110	125	146	24

SKU	DESCRIPCIÓN / DESCRIPTION
0004035	Embut E Mini Aluminio LI
0004020	Embut E Mini Aluminio LM
0004010	Embut E Mini Anoloc LI
0004009	Embut E Mini Anoloc LM
0004152	Embut E Mini Negro LI
0004150	Embut E Mini Negro LM
0004151	Embut E Mini Blanco LI
0004153	Embut E Mini Blanco LM

854

- Backset de 15,5mm
- Para puertas de 25 a 50mm de espesor
- Para puertas corredizas de perfil de aluminio o madera, derechas o izquierdas
- Caja y cantonera en acero
- Cilindro de 5 pines
- Disponible con cilindro sencillo, doble y llave-mariposa

- 15.5mm backset
- For doors 25 to 50mm thick
- For sliding aluminum or wood doors, right or left handed doors
- Lock case and strike plate made of steel
- 5 pins cylinder
- Available in double and single cylinder

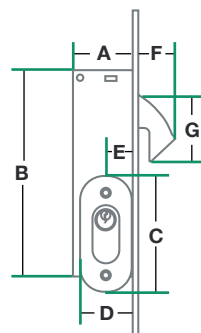

MEDIDAS EN mm. / MEASURES IN mm.						
A	B	C	D	E	F	G
32	100	55	24	15,5	18	33

SKU	DESCRIPCIÓN / DESCRIPTION
0004021	Embut 854 US26 S
0004022	Embut 854 US26 D
0004054	Embut 854 US26 LM
0004023	Embut 854 Caoba S
0004024	Embut 854 Caoba D
0004121	Embut 854 US26 S B
0004122	Embut 854 US26 D B
0004123	Embut 854 Caoba S B
0004124	Embut 854 Caoba D B

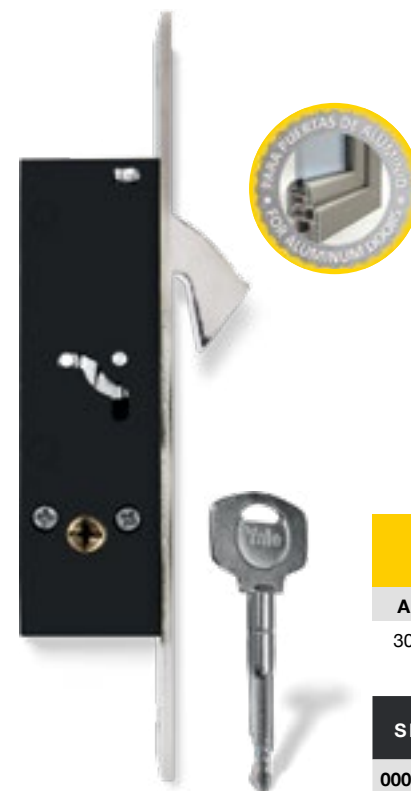

MEDIDAS EN mm. / MEASURES IN mm.				
A	B	C	D	E
30	104	19	18	30

SKU	DESCRIPCIÓN / DESCRIPTION
0007051	Embut 854 Tetra

854 Tetra

- Backset de 19mm
- Placa frontal, caja y cantonera en acero
- 5 llaves tetra

- 19mm backset
- Front plate, lock case and strike plate made of steel
- 5 cross keys



Cerradura pico de loro / Hookbolt mortise lock

- Cerrojo pico de loro en acero inoxidable con poyección ajustable
- Cilindro exterior en latón con 5 pines (opcional)
- 2 llaves en latón niquelado en referencia con el cilindro
- Ideal para perfiles de aluminio 8025 y 7038 o similares
- Recibidor y placa frontal en acero inoxidable

- Stainless steel hookbolt with adjustable projection
- Outer brass cylinder with 5 pins (optional)
- 2 nickel plated brass keys in reference with cylinder
- Ideal for 8025 y 7038 or similar aluminium profiles
- Stainless steel front plate and strike



MEDIDAS EN mm. / MEASURES IN mm.						
A	B	C	D	E	F	G
215	156	26	14	17	27	187

SKU	DESCRIPCIÓN / DESCRIPTION
0004055	Embut Pico Loro Natural
0004056	Embut Pico Loro Natural Cil
0004058	Embut Pico Loro Anoloc
0004057	Embut Pico Loro Anoloc Cil
0004089	Embut Pico Loro Negro
0004090	Embut Pico Loro Negro Cil
0004091	Embut Pico Loro Blanco
0004092	Embut Pico Loro Blanco Cil

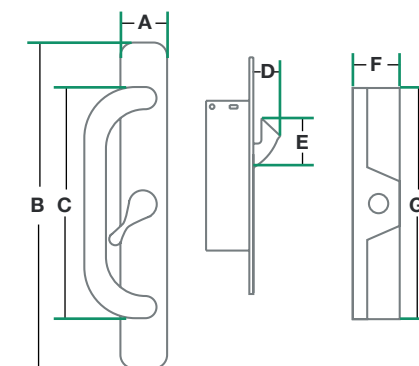

CAJAS Cases

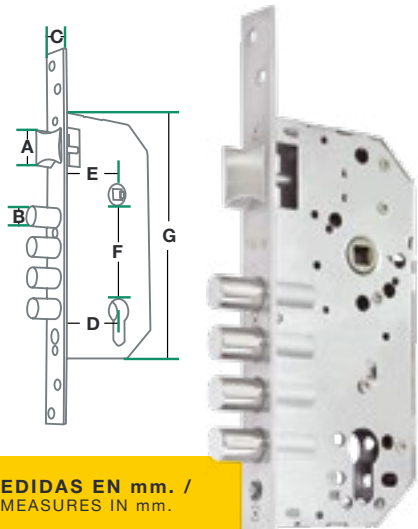

Cerradura embutir de 4 bulones / 4 bolts mortise lock

- 4 bulones de acero niquelado de diámetro de 14mm y proyección de 20mm
- Backset de 50 y 60mm
- Ideal para puertas de entrada principal de metal o de madera
- Placa frontal en acero inoxidable
- Distancia entre ejes de 85mm
- Pestillo reversible para puertas de cualquier mano que abran hacia adentro o hacia afuera
- 4 nickel plated bolts, 14mm diameter, and 20mm projection
- Backset : 50 and 60mm
- Recommended for main entrance wood or metal doors
- Stainless steel face plate
- Distance from lever to cylinder 85mm
- Reversible latch for right or left handed doors, opening inward or outward



MEDIDAS EN mm. /
MEASURES IN mm.

	A	B	C	D	E	F	G
50	26	14	23	50	50	85	175
60	27	14	23	60	60	85	175

SKU DESCRIPCIÓN /
DESCRIPTION

0010520	Embut 50mm 4bulones AI
0004093	Embut 60mm 4bulones AI

Cerradura de embutir 45mm / 45mm Mortise lock

- Para puertas de metal o madera
- Cerrojo con proyección de 20mm
- 45mm de backset
- Placa frontal en acero inoxidable
- Distancia entre ejes de 85mm
- Pestillo reversible para puertas de abrir hacia afuera
- For metal or wood doors
- Bolt with 20mm projection
- Backset: 45mm
- Stainless steel face plate
- Distance from lever to cylinder 85mm
- Reversible latch for outswinging doors

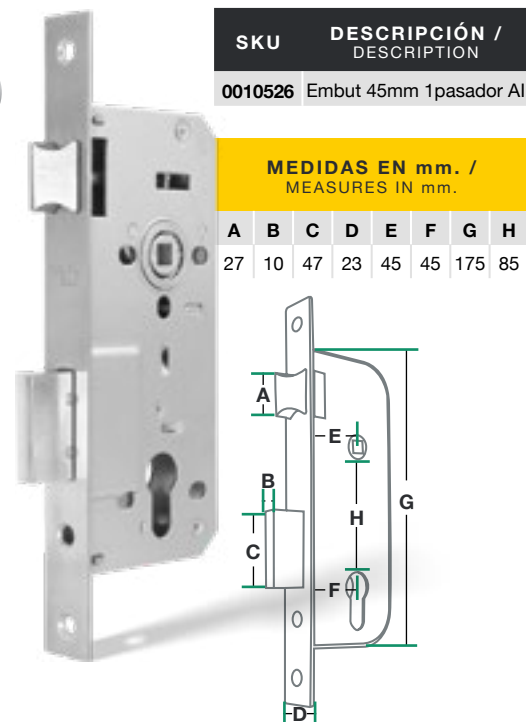

SKU DESCRIPCIÓN /
DESCRIPTION

0010526	Embut 45mm 1pasador AI
---------	------------------------

MEDIDAS EN mm. /
MEASURES IN mm.

A	B	C	D	E	F	G	H
27	10	47	23	45	45	175	85

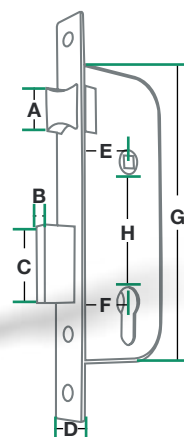

Cerradura de embutir de 3 puntos de cierre / 3 points mortise lock

- Backset de 50mm
- 10 bulones de acero de 14mm: 4 en la cerradura central y 3 en las cerraduras superior e inferior
- Pestillo reversible para puertas de abrir hacia afuera
- Distancia entre ejes de 85mm
- Compatible con cilindros euro profile YALE para cerraduras de embutir
- Backset: 50mm
- 10 steel bolts, 14mm: 4 in the middle lock, 3 in top and lower locks
- Reversible latch for outswinging doors
- Distance from lever to cylinder 85mm
- Compatible with euro profile Yale cylinders for mortise locks



SKU: 0007053

Disponible también en Kit con cilindro llave llave y escudo antitaladro

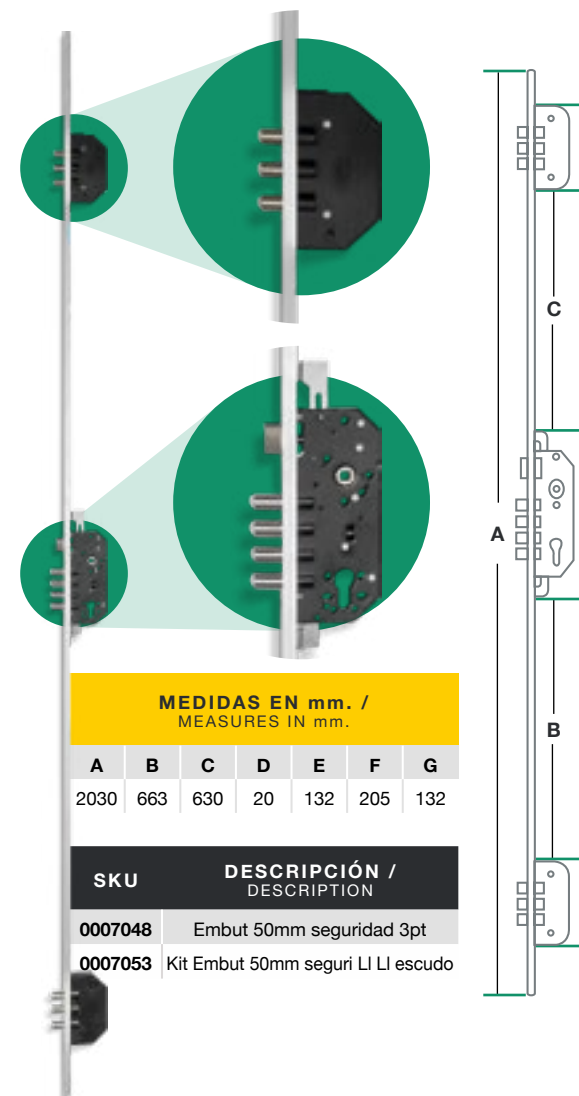

MEDIDAS EN mm. /
MEASURES IN mm.

A	B	C	D	E	F	G
2030	663	630	20	132	205	132

SKU DESCRIPCIÓN /
DESCRIPTION

0007048	Embut 50mm seguridad 3pt
0007053	Kit Embut 50mm seguri LI LI escudo

Cerrojo de embutir 3 bulones / 3 bolts mortise deadbolt

- Backset de 50mm
- 3 bulones de acero de 14mm de diámetro y proyección de 20mm
- Cuerpo y placa frontal en acero
- Escudo antitaladro para cilindro con diámetro de 64mm
- Cilindro en latón de 62mm, Llave-llave y llave-mariposa
- 6 pines
- 5 llaves multipunto
- Backset: 50mm
- 3 steel bolts, 14mm diameter and 20mm projection
- Steel body and face plate
- Security rosette for cylinder with 64mm diameter
- 62mm brass cylinder key-key or key-thumbturn
- 6 pins
- 5 dimple keys

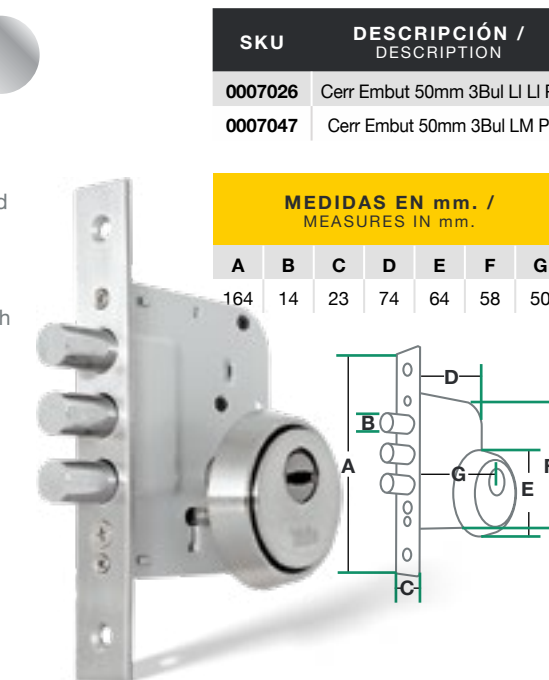

SKU DESCRIPCIÓN /
DESCRIPTION

0007026	Cerr Embut 50mm 3Bul LI LI P
0007047	Cerr Embut 50mm 3Bul LM P

MEDIDAS EN mm. /
MEASURES IN mm.

A	B	C	D	E	F	G
164	14	23	74	64	58	50

MANIJAS Levers

Manija Milán con placa / Milan lever with plate

- Manija para cerradura de embutir
- Manija y placas en acero inoxidable
- Distancia entre centros de 85mm
- Placa doble con tornillos ocultos
- Lever for mortise lock
- Stainless steel lever and plate
- Distance from centers of 85mm
- Double plate with hidden screws

SKU	DESCRIPCIÓN / DESCRIPTION
0007057	Manija Milán Placa R AI
0007058	Manija Milán Placa C AI

MEDIDAS EN mm. / MEASURES IN mm.										
A	B	C	D	E	F	G	H	I	J	
245	10	43	85	135	245	10	43	85	135	

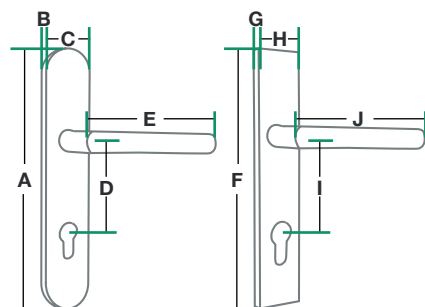

Con cuadrante para fijar manija exterior

Manija Génova con placa / Genova lever with plate

- Manija para cerradura de embutir
- Manija en zamac y placas en acero inoxidable
- Distancia entre centros de 85mm
- Placa doble con tornillos ocultos
- Lever for mortise lock
- Zamac lever and stainless steel plate
- Distance from centers of 85mm
- Double plate with hidden screws

SKU	DESCRIPCIÓN / DESCRIPTION
0007061	Manija Génova Placa R AI
0007062	Manija Génova Placa C AI

MEDIDAS EN mm. / MEASURES IN mm.										
A	B	C	D	E	F	G	H	I	J	
245	10	43	85	120	245	10	43	85	120	

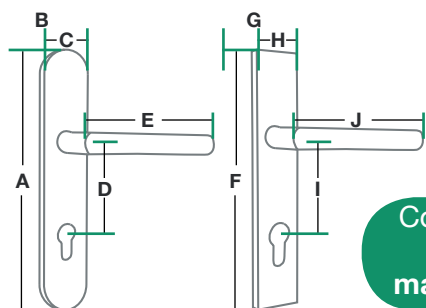

Con cuadrante para fijar manija exterior

Manija Bari con placa / Bari lever with plate



- Manija para cerradura de embutir
- Manija en zamac y placas en acero inoxidable
- Distancia entre centros de 85mm
- Placa doble con tornillos ocultos
- Lever for mortise lock
- Zamac lever and stainless steel plate
- Distance from centers of 85mm
- Double plate with hidden screws

SKU	DESCRIPCIÓN / DESCRIPTION
0007059	Manija Bari Placa R AI
0007060	Manija Bari Placa C AI
0007139	Manija Bari Placa C US5
0007140	Manija Bari Placa C US10B

MEDIDAS EN mm. / MEASURES IN mm.										
A	B	C	D	E	F	G	H	I	J	
245	10	43	85	120	245	10	43	85	120	

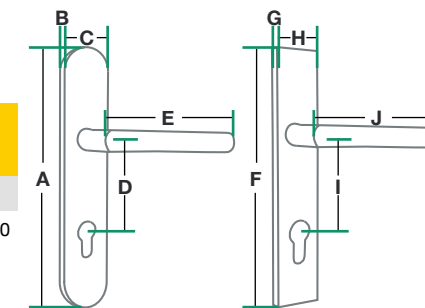

Con cuadrante para fijar manija exterior

Manija Austin con placa / Austin lever with plate



- Manija para cerradura de embutir
- Manija en zamac y placas en acero inoxidable
- Distancia entre centros de 85mm
- Placa doble con tornillos ocultos
- Lever for mortise lock
- Zamac lever and stainless steel plate
- Distance from centers of 85mm
- Double plate with hidden screws

SKU	DESCRIPCIÓN / DESCRIPTION
0010524	Manija Austin Placa R US26D
0010523	Manija Austin Placa R US5
0010522	Manija Austin Placa R US10B

MEDIDAS EN mm. / MEASURES IN mm.				
A	B	C	D	E
245	10	43	85	118

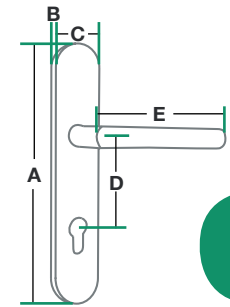

Con cuadrante para fijar manija exterior

Manija Milán / Milan lever

- Manija para cerradura de embutir
- Cuerpo en acero inoxidable
- Lever for mortise locks
- Stainless steel body

Con cuadrante para fijar manija exterior

SKU	DESCRIPCIÓN / DESCRIPTION
0010518	Manija Milán Roseta R Al
0010519	Manija Milán Roseta C Al

MEDIDAS EN mm. / MEASURES IN mm.			
A	B	C	D
135	59	54	19

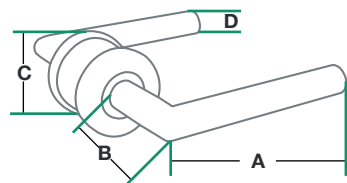

MEDIDAS EN mm. / MEASURES IN mm.			
E	F	G	H
135	59	54	19

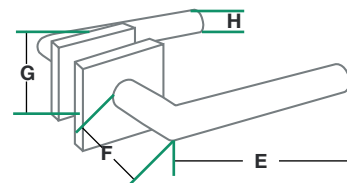

Manija Génova / Genova lever

- Manija para cerradura de embutir
- Manija en zamac y placas en acero inoxidable
- Lever for mortise locks
- Zamac lever and stainless steel plate

Con cuadrante para fijar manija exterior

MEDIDAS EN mm. / MEASURES IN mm.			
A	B	C	D
120	53	54	11

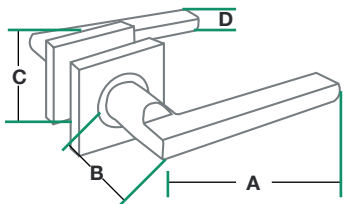

MEDIDAS EN mm. / MEASURES IN mm.			
F	G	H	I
120	53	54	11

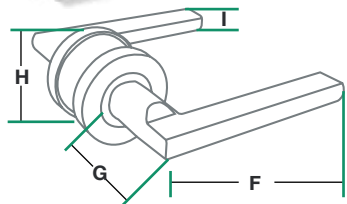

Manija Bari / Bari lever

- Manija para cerradura de embutir
- Manija en zamac y placas en acero inoxidable
- Lever for mortise locks
- Zamac lever and stainless steel plate

Con cuadrante para fijar manija exterior

SKU	DESCRIPCIÓN / DESCRIPTION
0010515	Manija Bari Roseta C Al

MEDIDAS EN mm. / MEASURES IN mm.			
A	B	C	D
135	40	54	23

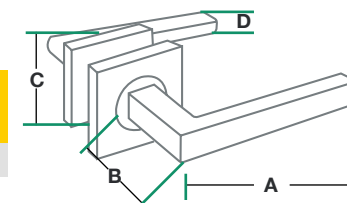

Manija Austin / Austin lever

- Manija para cerradura de embutir
- Manija en zamac y placas en acero inoxidable
- Lever for mortise locks
- Stainless steel body

Con cuadrante para fijar manija exterior

MEDIDAS EN mm. / MEASURES IN mm.			
E	F	G	H
118	40	54	19

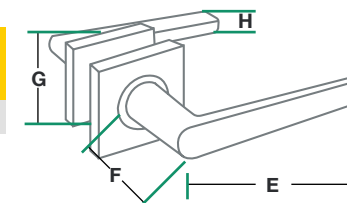

MEDIDAS EN mm. / MEASURES IN mm.			
A	B	C	D
118	40	54	19

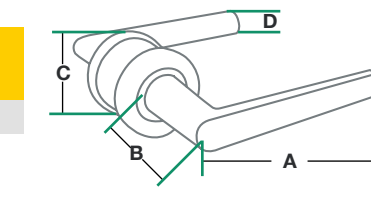

Manija Roma / Roma lever

- Manija para cerradura de embutir
- Cuerpo en acero inoxidable
- Lever for mortise locks
- Stainless steel body

Con cuadrante para fijar manija exterior

SKU	DESCRIPCIÓN / DESCRIPTION
0010517	Manija Roma Al

MEDIDAS EN mm. / MEASURES IN mm.			
A	B	C	D
137	61	54	19

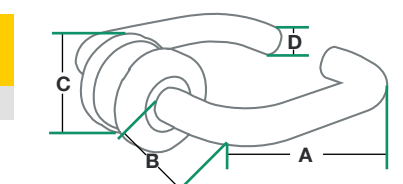

CILINDROS Cylinders

SKU	DESCRIPCIÓN / DESCRIPTION
0010538	Cil 62mm LI LI Plus US15
0010537	Cil 62mm LM Plus US15
0009093	Cil 70mm LI LI Plus US15
0009092	Cil 70mm LM Plus US15

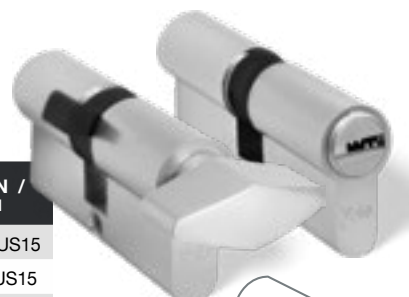

Cilindro de 62 y 70mm / 62 and 70mm cylinder

- Para puertas con espesor de hasta 42mm (cilindro de 62mm) y 50mm (cilindro de 70mm)
- Cilindro en latón de 62mm y 70mm
- 6 pines
- 5 llaves multipunto
- For doors up to 42mm thick (62mm cylinder) and 50mm (70mm cylinder)
- 62mm and 70mm brass cylinder
- 6 pins
- 5 dimple keys

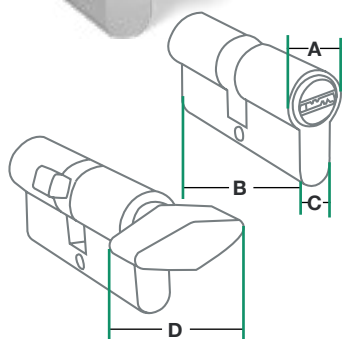

MEDIDAS EN mm. / MEASURES IN mm.

	A	B	C	D
62	17	62	10	31
70	17	70	10	31

Cilindro función baño / Privacy cylinder

- Para puertas con espesor de hasta 42mm
- Cilindro en latón de 62mm
- Acabado niquel satinado US15
- For doors up to 42mm thick
- 62mm brass cylinder
- Satin nickel finished

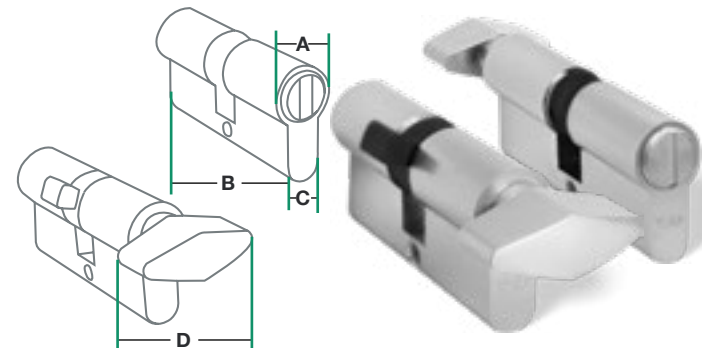

MEDIDAS EN mm. / MEASURES IN mm.

A	B	C	D
17	62	10	31

SKU	DESCRIPCIÓN / DESCRIPTION
0007046	Cil 62mm baño US15



SKU	DESCRIPCIÓN / DESCRIPTION
0009083	Escudo antitaladro US15

MEDIDAS EN mm. / MEASURES IN mm.

A
64

Escudo antitaladro / Security rosette

- Escudo de seguridad para cilindro
- Diámetro: 64mm
- Security rosette
- Diameter: 64mm

KITS Kits

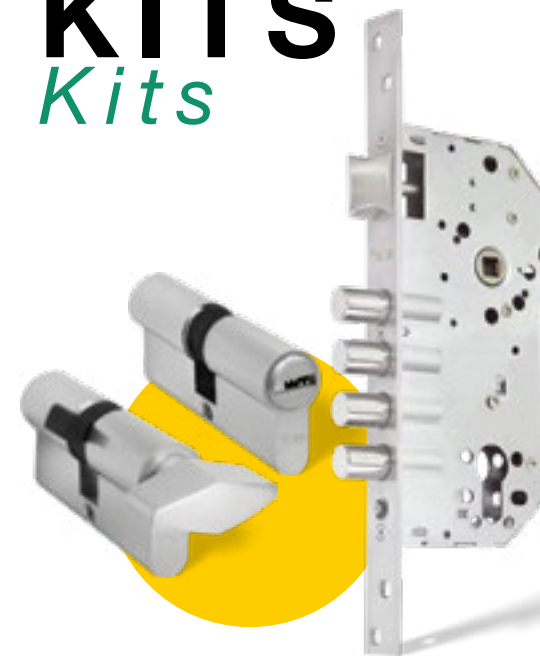

Cerradura de 50mm 4 bulones + cilindro / 50mm and 4 bolts mortise lock + cylinder kits

62mm

SKU	DESCRIPCIÓN / DESCRIPTION
0006662	Kit Embut 50mm Cil 62 LI P
0006666	Kit Embut 50mm Cil 62 LM P

70mm

SKU	DESCRIPCIÓN / DESCRIPTION
0006685	Kit Embut 50mm Cil 70 LI P
0006684	Kit Embut 50mm Cil 70 LM P

Cerradura de 50mm 4 bulones + manija roseta redonda + cilindro / 50mm and 4 bolts mortise lock + round rosette lever + cylinder combo

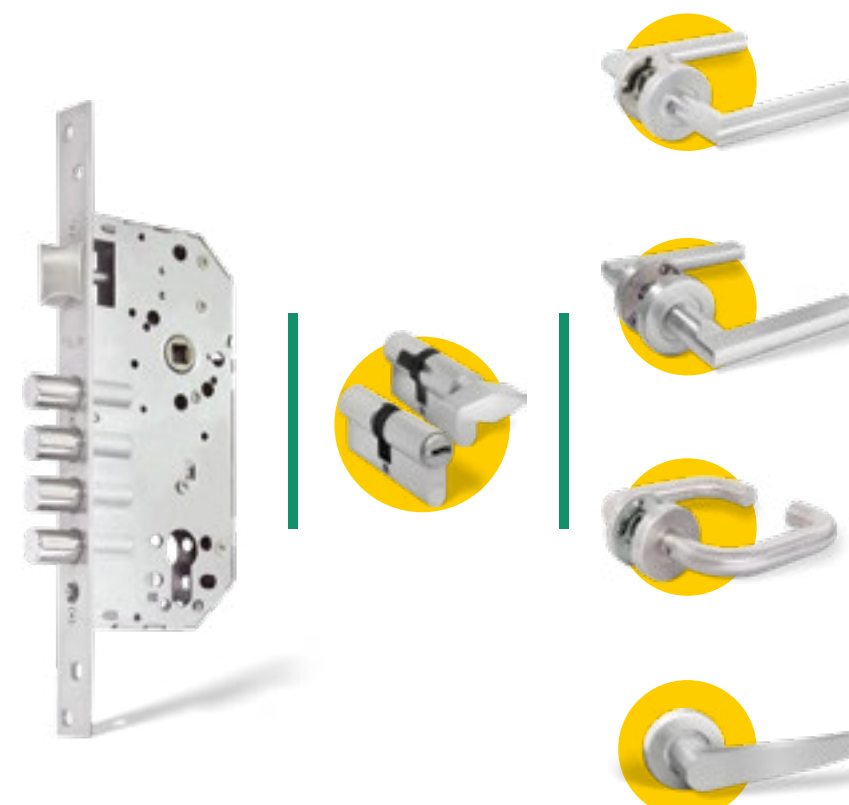

Milán

SKU	DESCRIPCIÓN / DESCRIPTION
0006625	Combo 4 Bul Milan Roseta R Cil 62 LI
0006626	Combo 4 Bul Milan Roseta R Cil 62 LM

Génova

SKU	DESCRIPCIÓN / DESCRIPTION
0006686	Combo 4 Bul Genov Roseta R Cil 62 LI
0006687	Combo 4 Bul Genov Roseta R Cil 62 LM

Roma

SKU	DESCRIPCIÓN / DESCRIPTION
0006627	Combo 4 Bul Roma Roseta R Cil 62 LI
0006624	Combo 4 Bul Roma Roseta R Cil 62 LM

Austin

SKU	DESCRIPCIÓN / DESCRIPTION
0006781	Combo 4 Bul Austin Roseta R Cil 62 LI
0006783	Combo 4 Bul Austin Roseta R Cil 62 LM

Cerradura de 50mm 4 bulones + escudo + manija roseta redonda + cilindro /
50mm and 4 bolts mortise lock + security rosette + round rosette lever + cylinder combo

Milán



SKU	DESCRIPCIÓN / DESCRIPTION
0006707	Combo 4 Bul Milan Roseta R Cil 62 LI Esc
0006711	Combo 4 Bul Milan Roseta R Cil 62 Lm Esc

Génova

SKU	DESCRIPCIÓN / DESCRIPTION
0006713	Combo 4 Bul Genov Roseta R Cil 62 LI Esc
0006706	Combo 4 Bul Genov Roseta R Cil 62 Lm Esc

Roma

SKU	DESCRIPCIÓN / DESCRIPTION
0006714	Combo 4 Bul Roma Roseta R Cil 62 LI Esc
0006704	Combo 4 Bul Roma Roseta R Cil 62 Lm Esc

Austin

SKU	DESCRIPCIÓN / DESCRIPTION
0006780	Combo 4 Bul Austin Roseta R Cil 62 LI Esc
0006782	Combo 4 Bul Austin Roseta R Cil 62 Lm Esc

Milán

SKU	DESCRIPCIÓN / DESCRIPTION
0006631	Combo 4 Bul Milan Roseta C Cil 62 LI
0006629	Combo 4 Bul Milan Roseta C Cil 62 LM

Génova

SKU	DESCRIPCIÓN / DESCRIPTION
0006630	Combo 4 Bul Genova Roseta C Cil 62 LI
0006633	Combo 4 Bul Genova Roseta C Cil 62 LM

Bari

SKU	DESCRIPCIÓN / DESCRIPTION
0006634	Combo 4 Bul Bari Roseta C Cil 62 LI
0006632	Combo 4 Bul Bari Roseta C Cil 62 LM

Austin

SKU	DESCRIPCIÓN / DESCRIPTION
0006777	Combo 4 Bul Austin Roseta C Cil 62 LI
0006779	Combo 4 Bul Austin Roseta C Cil 62 LM

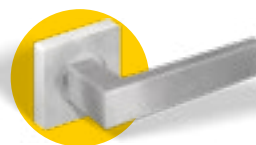
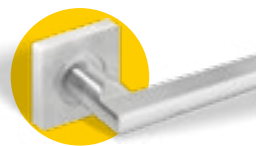

Cerradura de 50mm 4 bulones + manija roseta cuadrada + cilindro /
50mm and 4 bolts mortise lock + square rosette lever + cylinder combo



Cerradura de 50mm 4 bulones + escudo + manija roseta cuadrada + cilindro /
50mm and 4 bolts mortise lock + security rosette + square rosette lever + cylinder combo

Milán



SKU	DESCRIPCIÓN / DESCRIPTION
0006710	Combo 4 Bul Milan Roseta C Cil 62 LI Esc
0006715	Combo 4 Bul Milan Roseta C Cil 62 Lm Esc

Génova

SKU	DESCRIPCIÓN / DESCRIPTION
0006705	Combo 4 Bul Genova Roseta C Cil 62 LI Esc
0006709	Combo 4 Bul Genova Roseta C Cil 62 Lm Esc

Bari

SKU	DESCRIPCIÓN / DESCRIPTION
0006708	Combo 4 Bul Bari Roseta C Cil 62 LI Esc
0006712	Combo 4 Bul Bari Roseta C Cil 62 Lm Esc

Austin

SKU	DESCRIPCIÓN / DESCRIPTION
0006776	Combo 4 Bul Austin Roseta C Cil 62 LI Esc
0006778	Combo 4 Bul Austin Roseta C Cil 62 LM Esc

Un diseño, todos los ambientes
Línea Bari

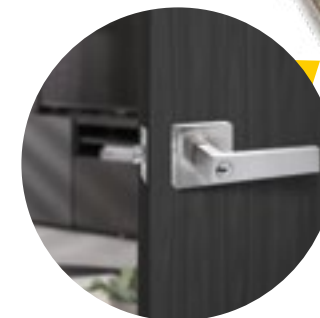



Milán redonda

SKU	DESCRIPCIÓN / DESCRIPTION
0007065	Combo 4 Bul Milan Placa R Cil 62 LI
0007064	Combo 4 Bul Milan Placa R Cil 62 LM

Milán cuadrada

SKU	DESCRIPCIÓN / DESCRIPTION
0007067	Combo 4 Bul Milan Placa C Cil 62 LI
0007066	Combo 4 Bul Milan Placa C Cil 62 LM

Génova redonda

SKU	DESCRIPCIÓN / DESCRIPTION
0007073	Combo 4 Bul Genova Placa R Cil 62 LI
0007072	Combo 4 Bul Genova Placa R Cil 62 LM

Génova cuadrada

SKU	DESCRIPCIÓN / DESCRIPTION
0007075	Combo 4 Bul Genova Placa C Cil 62 LI
0007074	Combo 4 Bul Genova Placa C Cil 62 LM

Bari redonda

SKU	DESCRIPCIÓN / DESCRIPTION
0007069	Combo 4 Bul Bari Placa R Cil 62 LI
0007068	Combo 4 Bul Bari Placa R Cil 62 LM

Bari cuadrada

SKU	DESCRIPCIÓN / DESCRIPTION
0007071	Combo 4 Bul Bari Placa C Cil 62 LI
0007070	Combo 4 Bul Bari Placa C Cil 62 LM

Austin redonda

SKU	DESCRIPCIÓN / DESCRIPTION
0006774	Combo 4 Bul Austin Placa C Cil 62 LI US26D
0006775	Combo 4 Bul Austin Placa C Cil 62 LM US26D
0006771	Combo 4 Bul Austin Placa C Cil 62 LI US5
0006770	Combo 4 Bul Austin Placa C Cil 62 LM US5
0006772	Combo 4 Bul Austin Placa C Cil 62 LI US10B
0006773	Combo 4 Bul Austin Placa C Cil 62 LM US10B

Cerradura de 50mm 4 bulones + manija con placa + cilindro / 50mm and 4 bolts mortise lock + lever with plate+ cylinder combo

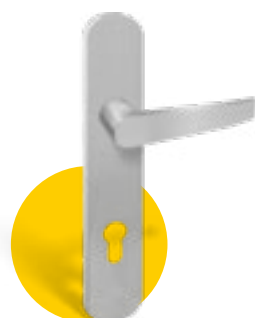
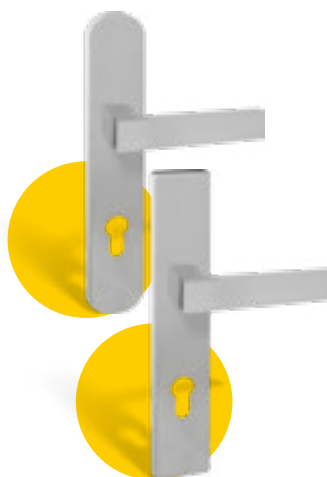
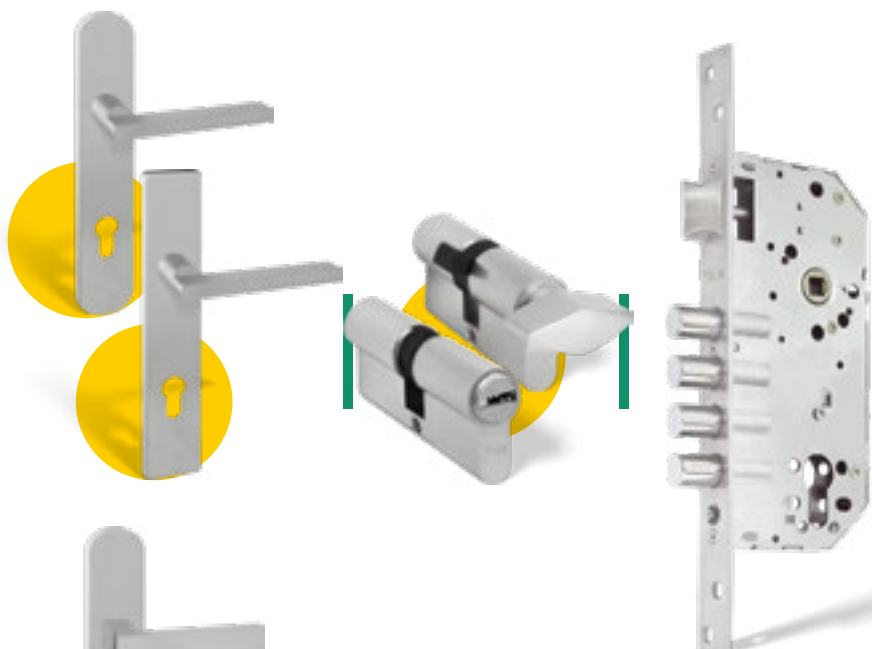
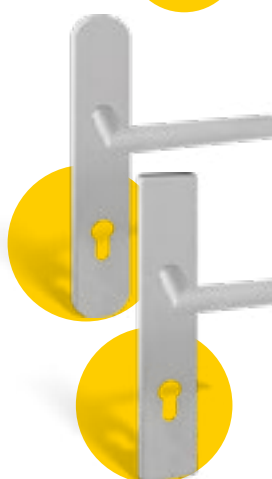

Ref. Manija Bari serie Black

RESIDENCIAL
Residential



La línea residencial de Yale tiene los más finos detalles y seguridad en sus modelos. Disponibles en varios acabados y estilos que servirán para mejorar el diseño de los hogares.

Nuestra línea ofrece variedad de diseños de pomos, manijas, cerrojos y manillones para cada necesidad de los hogares, ya sea una casa de familia, condominio o casas en conjuntos cerrados, la línea residencial Yale es la mejor opción para cumplir con sus necesidades.

Calidad y estilo mejorado de la cerradura más famosa del mundo.

Yale's residential collection captures the finest details and security in its products. Available in different finishes and styles to enhance homes design.

Our collection offers a wide variety of knobs, levers, deadbolts and leversets to meet the needs of today's housing market, whether your project includes townhomes, condos or a single family home, look no further than the Yale residential collection to fulfill your door hardware needs.

Enhanced quality & style from the world's favourite lock.

GLOSARIO

Glossary

Acabados / Finishes:



US3
Latón brillante / Bright brass



US5
Latón antiguo / Antique brass



US26D
Cromo satinado / Satin chrome



AI
Acero inoxidable / Stainless steel



US15
Níquel satinado / Satin nickel



US14
Níquel brillante / Bright nickel



Caoba / Brown



US10B
Negro / Black

Características / Features:



Instalación sencilla
Easy installation



Cuatro llaves
Four keys



Cuatro llaves
Four keys

Abreviatura / Abbreviation:

Baño: Baño / Privacy

Alc: Alcoba / Bedroom

Ent: Entrada / Entrance

LI-LI: Llave llave / Key to key

LI-Ma: Llave Mariposa / Key Thumb Turn

LI-Ci: Llave Ciega / Single Cylinder

Cerr: Cerrojo / Deadbolt

P: Plus / Plus

Combo: Combo / Combo

Man: Manillón / Leverset

B: Empaque blister / Visual pack

Vid: Ideal para puertas de vidrio / Great For Glass Doors

Resb: Pestillo resbalón / Latch



LÍNEA ELITE

Elite line

Pomos / Knobs

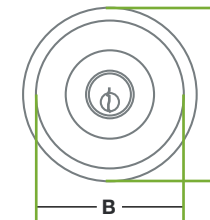

MEDIDAS EN mm. / MEASURES IN mm.	
A	B
64	54

Brandywine

- Para puertas de 35 a 45mm de espesor
- Pestillo reversible para puertas de cualquier mano de abrir hacia adentro o hacia afuera
- Pomo en madera Puy
- Backset de 60mm



- For doors 35 to 45mm thick
- Reversible latch for inside or outside opening doors right or left handed
- Puy wood knob
- 60mm backset



SKU	DESCRIPCIÓN / DESCRIPTION
0006019	Pomo Brandywine US3 Baño
0006038	Pomo Brandywine US3 Alc
0006066	Pomo Brandywine US3 Ent

Manijas / Levers

Capri

- Para puertas de 35 a 45mm de espesor
- Pestillos reversibles para puertas de cualquier mano que abran hacia adentro o hacia afuera
- Backset ajustable de 60 a 70mm



- For doors 35 to 45mm thick
- Reversible latch for inside or outside opening doors, right or left handed
- Adjustable backset: 2 3/8" (60mm) to 2 3/4" (70mm)



MEDIDAS EN mm. / MEASURES IN mm.		
A	B	C
69,5	144	128

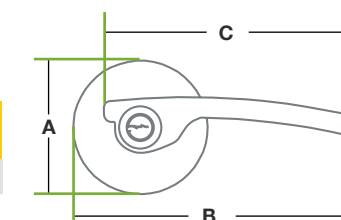

SKU	DESCRIPCIÓN / DESCRIPTION
0009052	Manija Capri US15 Baño
0009053	Manija Capri US15 Alc
0009058	Manija Capri US15 Ent
0009080	Manija Capri US15 Baño B
0009081	Manija Capri US15 Alc B
0009082	Manija Capri US15 Ent B

Palermo

- Para puertas de 35 a 45mm de espesor
- Pestillo reversible para puertas de cualquier mano que abran hacia adentro o hacia afuera
- Backset ajustable de 60 a 70mm

- For doors 35 to 45mm thick
- Reversible latch for inside or outside opening doors, right or left handed
- Adjustable backset: 2 3/8" (60mm) to 2 3/4" (70mm)



MEDIDAS EN mm. / MEASURES IN mm.		
A	B	C
66	143	123

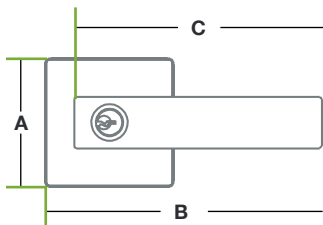

SKU	DESCRIPCIÓN / DESCRIPTION
0009046	Manija Palermo US15 Baño
0009048	Manija Palermo US15 Alc
0009047	Manija Palermo US15 Ent

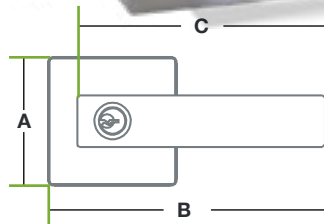

MEDIDAS EN mm. / MEASURES IN mm.		
A	B	C
65	140	119

SKU	DESCRIPCIÓN / DESCRIPTION
0009054	Manija Bari US15 Baño
0009055	Manija Bari US15 Alc
0009059	Manija Bari US15 Ent
0009101	Manija Bari US5 Baño
0009102	Manija Bari US5 Alc
0009100	Manija Bari US5 Ent
0009077	Manija Bari US15 Baño B
0009078	Manija Bari US15 Alc B
0009079	Manija Bari US15 Ent B

Bari

- Para puertas de 35 a 45mm de espesor
- Pestillo reversible para puertas de cualquier mano que abran hacia adentro o hacia afuera
- Backset ajustable de 60 a 70mm

- For doors 35 to 45mm thick
- Reversible latch for inside or outside opening doors, right or left handed
- Adjustable backset: 2 3/8" (60mm) to 2 3/4" (70mm)



MEDIDAS EN mm. / MEASURES IN mm.		
A	B	C
65	140	119

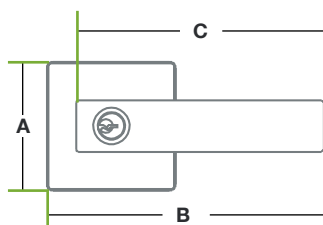

SKU	DESCRIPCIÓN / DESCRIPTION
0009104	Manija Bari US10B Baño
0009105	Manija Bari US10B Alc
0009103	Manija Bari US10B Ent



Bari SERIE BLACK

- Para puertas de 35 a 45mm de espesor
- Pestillo reversible para puertas de cualquier mano que abran hacia adentro o hacia afuera
- Backset ajustable de 60 a 70mm

- For doors 35 to 45mm thick
- Reversible latch for inside or outside opening doors, right or left handed
- Adjustable backset: 2 3/8" (60mm) to 2 3/4" (70mm)

Asis

- Para puertas de 35 a 45mm de espesor
- Pestillo reversible para puertas de cualquier mano que abran hacia adentro o hacia afuera
- Backset ajustable de 60 a 70mm

- For doors 35 to 45mm thick
- Reversible latch for inside or outside opening doors, right or left handed
- Adjustable backset: 2 3/8" (60mm) to 2 3/4" (70mm)



MEDIDAS EN mm. / MEASURES IN mm.		
A	B	C
65	135	121

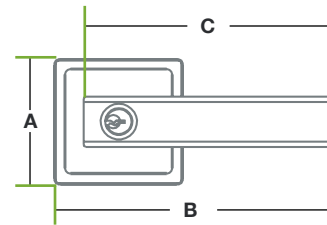

SKU	DESCRIPCIÓN / DESCRIPTION
0009056	Manija Asis US15 Baño
0009057	Manija Asis US15 Alc
0009060	Manija Asis US15 Ent



Manillones / Leversets

Toscana

- Manillón para entrada principal
- Reversibles para puertas derechas e izquierdas
- Backset ajustable a 60 o 70mm
- Para puertas de 35 a 45mm de espesor
- Sistema llave-llave o llave-mariposa
- 120mm entre centros

- Main entrance leverset
- Reversible for right or left handed doors
- Adjustable backset: from 2 3/8" (60mm) to 2 3/4" (70mm)
- For 35 to 45mm thick doors
- Single or double cylinder leverset
- 120mm between centers



SKU	DESCRIPCIÓN / DESCRIPTION
0009089	Man Toscana US15 LM
0009090	Man Toscana US15 LI LI

MEDIDAS EN mm. / MEASURES IN mm.			
A	B	C	D
394	64	115	206

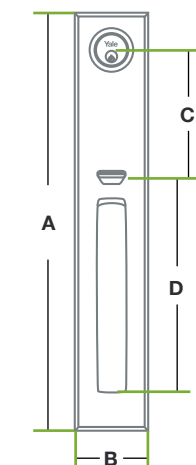



Cerrojos / Deadbolts



Viena

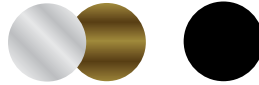

SERIE BLACK

- Backset ajustable a 60 o 70mm
- Para puertas de abrir hacia adentro o hacia afuera, izquierdas o derechas
- Para puertas de 35 a 45mm de espesor
- El pestillo se acciona por ambos lados con la llave
- Adjustable backset: 2 3/8" (60mm) to 2 3/4" (70mm)
- For inside or outside opening doors, right or left handed
- For doors 35 to 45mm thick
- Latch is operated form both sides with the key

SKU	DESCRIPCIÓN / DESCRIPTION
0004104	Cerr Viena US10B LI LI P
0004105	Cerr Viena US15 LI LI P
0004106	Cerr Viena US5 LI LI P

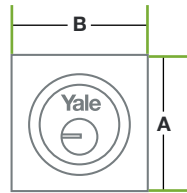

MEDIDAS EN mm. / MEASURES IN mm.	
A	B
63	63

Parma



- Backset de 60mm
- Para puertas de abrir hacia adentro o hacia afuera, izquierdas o derechas
- Para puertas de 32 a 42mm de espesor
- 4 llaves planas reversibles multipunto con cilindro de alta seguridad
- El pestillo se acciona por ambos lados con la llave
- Backset: 60mm
- For inside or outside opening doors, right or left handed
- For doors 32 to 42mm thick
- 4 dimple keys with a high security cylinder
- Latch is operated form both sides with the key



SKU	DESCRIPCIÓN / DESCRIPTION
0006623	Cerr Parma US15 LI-LI P

MEDIDAS EN mm. / MEASURES IN mm.				
A	B	C	D	E
93	63	60	21	19

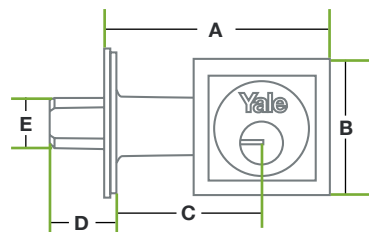

Cerrojo 170 Plus / 170 Plus Deadbolt

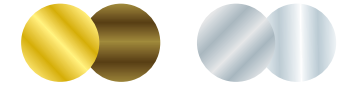

- Backset de 60mm
- Para puertas de abrir hacia adentro o hacia afuera, izquierdas o derechas de 32 a 42mm de espesor
- 4 llaves planas reversibles multipunto con cilindro de alta seguridad
- Backset: 60mm
- For inside or outside opening doors, right or left handed 32 to 42mm thick
- 4 dimple keys with a high security cylinder

SKU	DESCRIPCIÓN / DESCRIPTION
0004082	Cerr 170 US14 LM P
0004038	Cerr 170 US14 LI LI P
0004039	Cerr 170 US3 LI LI P
0004087	Cerr 170 US26D LI LI P
0004088	Cerr 170 US5 LI LI P
0004083	Cerr 170 US14 LM P B
0004043	Cerr 170 US14 LI LI P B
0004042	Cerr 170 US3 LI LI P B

MEDIDAS EN mm. / MEASURES IN mm.				
A	B	C	D	E
86,8	53,5	60	22,3	19

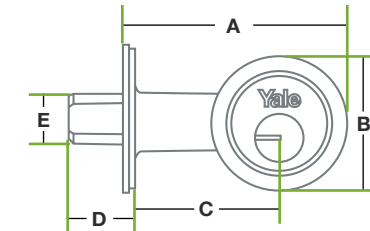

LÍNEA TRADICIONAL

Traditional line

Pomos / Knobs

Litchfield

- Para puertas de 35 a 45mm de espesor
- Pestillo reversible para puertas de cualquier mano de abrir hacia adentro o hacia afuera
- Backset de 60mm
- For doors 35 to 45mm thick
- Reversible latch for inside or outside opening doors right or left handed
- 60mm backset



SKU	DESCRIPCIÓN / DESCRIPTION
0006373	Pomo Litchfield Al Baño
0006375	Pomo Litchfield Al Alc
0006378	Pomo Litchfield Al Ent

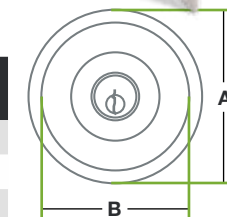

MEDIDAS EN mm. / MEASURES IN mm.	
A	B
64	57



SKU	DESCRIPCIÓN / DESCRIPTION
0006457	Pomo Carolina US5 Baño
0006458	Pomo Carolina US5 Alc
0006451	Pomo Carolina US5 Ent
0006374	Pomo Carolina AI Baño
0006376	Pomo Carolina AI Alc
0006377	Pomo Carolina AI Ent

Carolina

- Para puertas de 35 a 45mm de espesor
 - Pestillo reversible para puertas de cualquier mano de abrir hacia adentro o hacia afuera
 - Backset de 60mm
- For doors 35 to 45mm thick
 - Reversible latch for inside or outside opening doors right or left handed
 - 60mm backset

MEDIDAS EN mm. / MEASURES IN mm.	
A	B
64	53

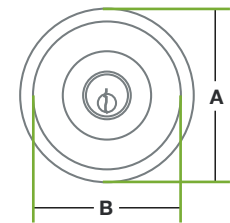

Carolina para puertas de 25mm / 25mm doors Carolina

- Para puertas de 25 a 35mm de espesor
 - Pestillo reversible para puertas de cualquier mano de abrir hacia adentro o hacia afuera
 - Backset ajustable a 60 o 70mm
- For doors 25 to 35mm thick
 - Reversible latch for inside or outside opening doors right or left handed
 - Adjustable backset to 60 or 70mm

MEDIDAS EN mm. / MEASURES IN mm.	
A	B
64	53

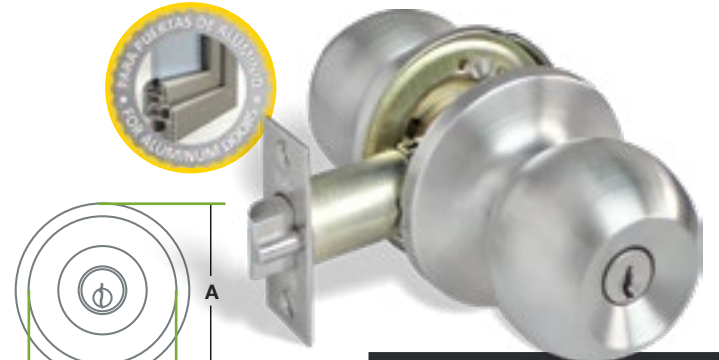

SKU	DESCRIPCIÓN / DESCRIPTION
0007112	Pomo Caro 25mm AI Alc
0007110	Pomo Caro 25mm AI Baño
0007113	Pomo Caro 25mm US5 Alc
0007111	Pomo Caro 25mm US5 Baño

Kit Carolina 2 de alcoba 1 de baño / Carolina kit 2 bedroom 1 privacy

- Para puertas de 35 a 45mm de espesor
 - Pestillo reversible para puertas de cualquier mano de abrir hacia adentro o hacia afuera
 - Backset de 60mm
- For doors 35 to 45mm thick
 - Reversible latch for inside or outside opening doors right or left handed
 - 60mm backset

SKU	DESCRIPCIÓN / DESCRIPTION
0006660	Kit Carolina AI 2A 1B



Manijas / Levers



Austin

- Para puertas de 35 a 45mm de espesor
 - Pestillo reversible para puertas de cualquier mano que abran hacia adentro o hacia afuera
 - Backset ajustable de 60mm
- For doors 35 to 45mm thick
 - Reversible latch for inside or outside opening doors, right or left handed
 - Backset: 2 3/8" (60mm)

SKU	DESCRIPCIÓN / DESCRIPTION
0006464	Manija Austin US5 Baño
0006462	Manija Austin US5 Alc
0006460	Manija Austin US5 Ent
0006478	Manija Austin US26D Baño
0006481	Manija Austin US26D Alc
0006476	Manija Austin US26D Ent

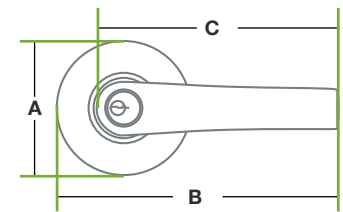

MEDIDAS EN mm. / MEASURES IN mm.		
A	B	C
65	126	107

Austin SERIE BLACK

- Para puertas de 35 a 45mm de espesor
 - Pestillo reversible para puertas de cualquier mano que abran hacia adentro o hacia afuera
 - Backset ajustable de 60mm
- For doors 35 to 45mm thick
 - Reversible latch for inside or outside opening doors, right or left handed
 - Backset: 2 3/8" (60mm)

MEDIDAS EN mm. / MEASURES IN mm.		
A	B	C
65	126	107

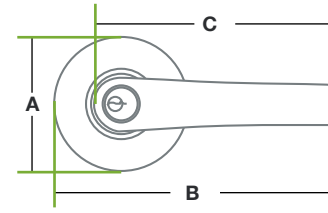

SKU	DESCRIPCIÓN / DESCRIPTION
0006466	Manija Austin US10B Baño
0006467	Manija Austin US10B Alc
0006465	Manija Austin US10B Ent



Diseño irresistible, la seguridad Yale de siempre

Kit Austin 2 de alcoba 1 de baño / Austin kit 2 bedroom 1 privacy

- Para puertas de 35 a 45mm de espesor
- Pestillo reversible para puertas de cualquier mano que abran hacia adentro o hacia afuera
- Backset ajustable de 60mm
- For doors 35 to 45mm thick
- Reversible latch for inside or outside opening doors, right or left handed
- Backset: 2 3/8" (60mm)



SKU	DESCRIPCIÓN / DESCRIPTION
0006659	Kit Austin US26D 2A 1B

MEDIDAS EN mm. / MEASURES IN mm.		
A	B	C
65	126	107

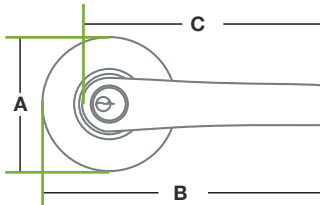

Atlanta

- Para puertas de 35 a 45mm de espesor
- Pestillo reversible para puertas de cualquier mano que abran hacia adentro o hacia afuera
- Backset ajustable de 60mm
- For doors 35 to 45mm thick
- Reversible latch for inside or outside opening doors, right or left handed
- Backset: 2 3/8" (60mm)

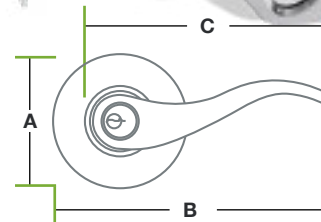

MEDIDAS EN mm. / MEASURES IN mm.		
A	B	C
65	140	121

SKU	DESCRIPCIÓN / DESCRIPTION
0006463	Manija Atlanta US5 Baño
0006461	Manija Atlanta US5 Alc
0006459	Manija Atlanta US5 Ent
0006479	Manija Atlanta US26D Baño
0006480	Manija Atlanta US26D Alc
0006477	Manija Atlanta US26D Ent

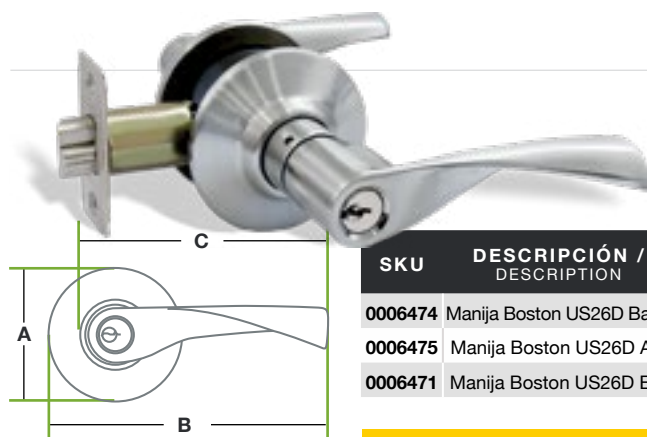

SKU	DESCRIPCIÓN / DESCRIPTION
0006474	Manija Boston US26D Baño
0006475	Manija Boston US26D Alc
0006471	Manija Boston US26D Ent

MEDIDAS EN mm. / MEASURES IN mm.		
A	B	C
65	140	121

Boston

- Para puertas de 35 a 45mm de espesor
- Pestillo reversible para puertas de cualquier mano que abran hacia adentro o hacia afuera
- Backset ajustable de 60mm
- For doors 35 to 45mm thick
- Reversible latch for inside or outside opening doors, right or left handed
- Backset: 2 3/8" (60mm)



Cerrojos / Deabolts



170

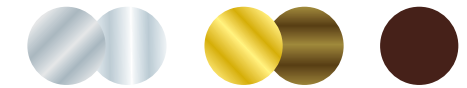

- Backset de 60mm
- Para puertas de abrir hacia adentro o hacia afuera, izquierdas o derechas de 32 a 42mm de espesor
- Referencia 170 1/4 Plus: pestillo se acciona por ambos lados con la llave
- Referencia 170M Plus: pestillo se acciona por el exterior con la llave y por el interior con la mariposa
- Referencia 170A Plus: pestillo se acciona unicamente por el exterior con la llave
- Backset: 60mm
- For inside or outside opening doors, right or left handed 32 to 42mm thick
- On the 170 1/4 Plus model the latch is operated from both sides with the key
- On the 170M Plus model the latch is operated on the outside with the key and on the inside with the thumb turn
- On the 170A Plus model the latch is operated only on the outside with the key

SKU	DESCRIPCIÓN / DESCRIPTION
0004014	Cerr 170 US14 LI CI
0004080	Cerr 170 US14 LM
0004011	Cerr 170 US14 LI LI
0004012	Cerr 170 US3 LI LI
0004084	Cerr 170 US5 LI LI
0004013	Cerr 170 Caoba LI LI
0004086	Cerr 170 US26D LM
0004085	Cerr 170 US26D LI LI
0004081	Cerr 170 US14 LM B
0004111	Cerr 170 US14 LI LI B
0004112	Cerr 170 US3 LI LI B
0004113	Cerr 170 Caoba LI LI B

MEDIDAS EN mm. / MEASURES IN mm.				
A	B	C	D	E
86.8	53,5	60	22,3	19

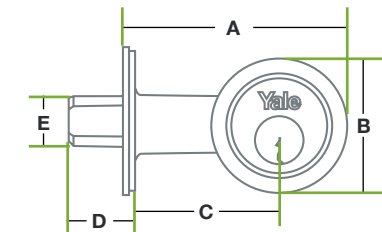

Cerrojo 170 con pestillo resbalón / 170 Deadbolt with latch

- Con función cerrojo de seguridad
- Backset de 60mm
- Para puertas de 32 a 42mm de espesor
- Pestillo reversible para puertas de cualquier mano que abran hacia adentro o hacia afuera
- Security bolt function
- Backset: 60mm
- For doors 32 to 42mm thick
- Reversible latch for inside or outside opening doors, right or left handed



Pestillo resbalón reversible

SKU	DESCRIPCIÓN / DESCRIPTION
0004044	Cerr 170 US26D Resb LI LI

MEDIDAS EN mm. / MEASURES IN mm.			
A	B	C	D
86.8	53,5	60	19

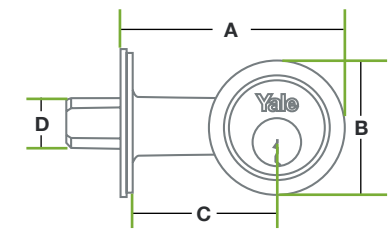



Cerrojo 170 para puertas de vidrio / 170 Deadbolt for glass doors

- Backset de 60mm
- Para puertas de 22 a 42mm de espesor
- Para puertas de cualquier mano que abran hacia adentro o hacia afuera, izquierda o derecha
- Backset: 60mm
- For doors 22 to 42mm thick
- For inside or outside opening doors, right or left handed

Incluye **accesorios y placa frontal más angosta** que disminuye la necesidad de suplementos y trabajos adicionales al instalar en puertas de vidrio.

SKU	DESCRIPCIÓN / DESCRIPTION
0004046	Cerr 170 US14 LI LI Vid
0004047	Cerr 170 US14 LM Vid

MEDIDAS EN mm. / MEASURES IN mm.			
A	B	C	D
86.8	53.5	60	19

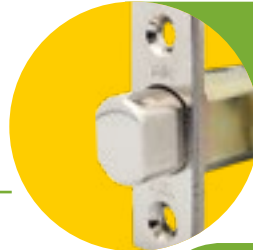
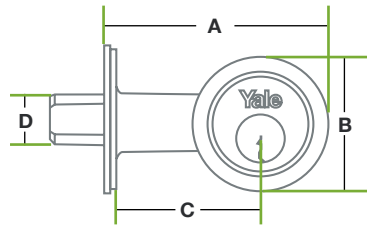

Placa frontal más angosta



Accesorios que disminuyen uso de suplementos

Combos Residenciales / Residential kits

Combo Carolina / Carolina combo

- Para puertas de 35 a 40mm de espesor
- Pestillo reversible para puertas de cualquier mano que abran hacia adentro o hacia afuera
- Backset de 60mm
- Escudo en acero
- 100mm entre centros
- For doors 35 to 40mm thick
- Reversible latch for inside or outside opening doors, right or left handed
- Backset: 60mm
- Steel shield
- 100mm between centers

SKU	DESCRIPCIÓN / DESCRIPTION
0006617	Combo Carolina US5 Ent
0006618	Combo Carolina US26D Ent

MEDIDAS EN mm. / MEASURES IN mm.					
A	B	C	D	E	F
215	85	100	53	64	53,5

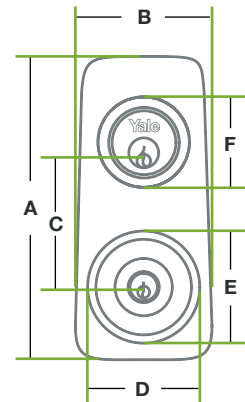

Combo Brandywine / Brandywine combo

- Para puertas de 35 a 40mm de espesor
- Pestillo reversible para puertas de cualquier mano que abran hacia adentro o hacia afuera
- Backset de 60mm
- Escudo en acero
- 100mm entre centros
- For doors 35 to 40mm thick
- Reversible latch for inside or outside opening doors, right or left handed
- Backset: 60mm
- Steel shield
- 100mm between centers

MEDIDAS EN mm. / MEASURES IN mm.					
A	B	C	D	E	F
215	85	100	53	64	53,5

SKU	DESCRIPCIÓN / DESCRIPTION
0006610	Combo Brandywine US3 Ent



Combo Austin / Austin combo

- Para puertas de 35 a 40mm de espesor
- Pestillo reversible para puertas de cualquier mano que abran hacia adentro o hacia afuera
- Backset de 60mm
- Escudo en acero
- 100mm entre centros
- For doors 35 to 40mm thick
- Reversible latch for inside or outside opening doors, right or left handed
- Backset: 60mm
- Steel shield
- 100mm between centers

SKU	DESCRIPCIÓN / DESCRIPTION
0006615	Combo Austin US5 Ent
0006616	Combo Austin US26D Ent

MEDIDAS EN mm. / MEASURES IN mm.					
A	B	C	D	E	F
215	85	100	107	64	53,5

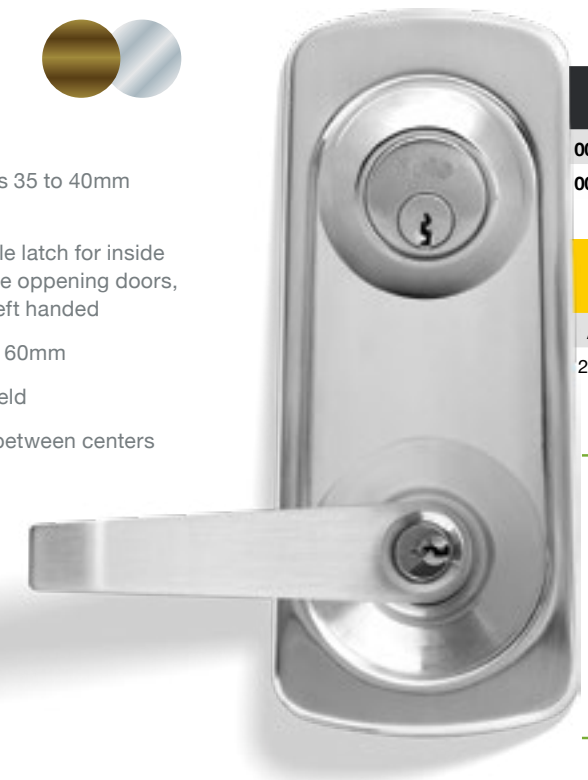
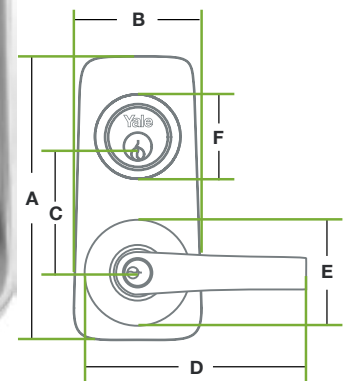

Combo Carolina + Kent con jaladera / Carolina + Kent with handle combo

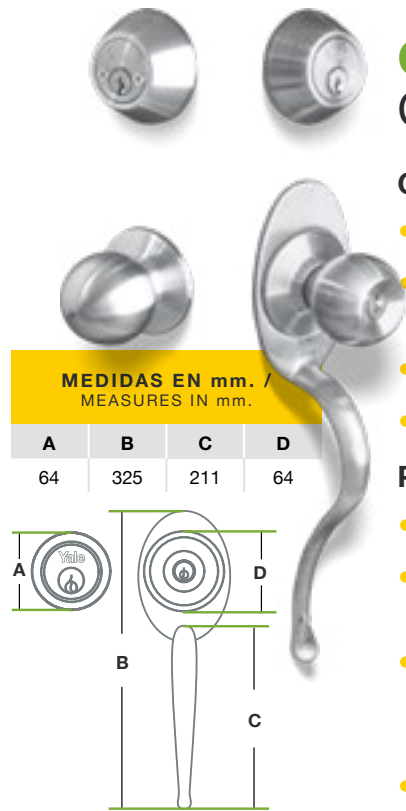

MEDIDAS EN mm. / MEASURES IN mm.

A	B	C	D
64	325	211	64

Cerrojo Kent

- Backset ajustable a 60mm o 70mm
- Para puertas de 35 a 45mm de espesor
- Sistema llave-llave o llave-mariposa
- 2 llaves

Pomo Carolina

- Backset de 60mm
- Para puertas de 35 a 45mm de espesor
- Pestillo reversible para puertas de cualquier mano de abrir hacia adentro o hacia afuera
- 2 llaves

Cerrojo Kent

- Adjustable backset: 60 or 70mm
- For doors 35 to 45mm thick
- Single or double cylinder
- 2 keys

Pomo Carolina

- 60mm backset
- For doors 35 to 45mm thick
- Reversible latch for inside or outside opening doors right or left handed
- 2 keys



SKU	DESCRIPCIÓN / DESCRIPTION
0006638	Caro-Kent LM Jalad AI
0006639	Caro-Kent LI Jalad AI

Manillones / Leversets

Liverpool

- Manillón para entrada principal
- Reversibles para puertas derechas e izquierdas
- Backset ajustable a 60 o 70mm
- Para puertas de 35 a 45mm de espesor
- Sistema llave-llave o llave-mariposa
- Main entrance leverset
- Reversible for right or left handed doors
- Adjustable backset: from 2 3/8" (60mm) to 2 3/4" (70mm)
- For 35 to 45mm thick doors
- Single or double cylinder leverset



MEDIDAS EN mm. / MEASURES IN mm.

A	B	C	D	E	F
284	68	97	202	78	57

LÍNEA ESTANDAR

Standard line

Pomos / Knobs

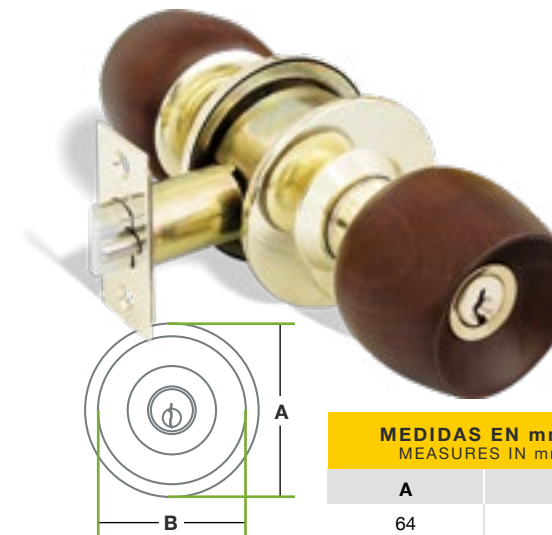

MEDIDAS EN mm. / MEASURES IN mm.

A	B
64	56

Dublin

- Para puertas de 35 a 45mm de espesor
- Pestillo reversible para puertas de cualquier mano que abran hacia adentro o hacia afuera
- Backset de 60mm



- For doors 35 to 45mm thick
- Reversible latch for inside or outside opening doors, right or left handed
- Backset: 60mm



SKU	DESCRIPCIÓN / DESCRIPTION
0006381	Pomo Dublín US3 Baño
0006382	Pomo Dublín US3 Alc

Manillones / Leversets

Wales

- Manillón para entrada principal
- Reversibles para puertas derechas e izquierdas
- Backset ajustable a 60 o 70mm
- Para puertas de 35 a 45mm de espesor
- Sistema llave-llave o llave-mariposa
- Main entrance leverset
- Reversible for right or left handed doors
- Adjustable backset: from 2 3/8" (60mm) to 2 3/4" (70mm)
- For 35 to 45mm thick doors
- Single or double cylinder leverset

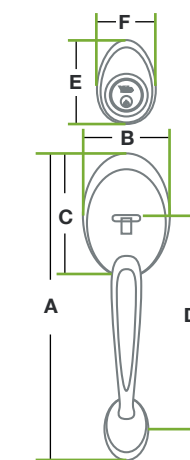

MEDIDAS EN mm. / MEASURES IN mm.

A	B	C	D	E	F
270	74	106	165	79	58

SKU	DESCRIPCIÓN / DESCRIPTION
0008991	Man Wales US26D LM
0008987	Man Wales US26D LI LI
0008988	Man Wales US3 LM
0009020	Man Wales US3 LI LI
0008989	Manillón Wales US5 LM
0008986	Manillón Wales US5 LI LI

Cerrojos / Deabolts



Kent

- Backset ajustable a 60mm o 70mm
- Para puertas de 35 a 45mm de espesor
- Sistema llave-llave o llave-mariposa
- 3 llaves
- 5 pines



SKU	DESCRIPCIÓN / DESCRIPTION
0004099	Cerr Kent US26D LM
0004100	Cerr Kent US26D LI LI
0004097	Cerr Kent US26D LM B
0004098	Cerr Kent US26D LI LI B

MEDIDAS EN mm. / MEASURES IN mm.

A
64



Tenemos las *soluciones* para tus proyectos

Bogotá, D.C

Ref. Candado alemán Black



CANDADOS
Padlocks



Yale ofrece la serie más amplia del mercado de candados con diseños exclusivos para distintos usos y condiciones climáticas. Las opciones de nuestros productos van desde la Serie Intemperie hasta la reconocida Serie Italiana. Por otro lado, la marca, en busca de innovar y satisfacer todas las soluciones de seguridad lanza al mercado la línea premier Serie Sueca, cables y candados especiales para Seguridad Portátil, la Serie Viajera.

La Serie Viajera incluye los candados TSA (autorizados por la Administración de Seguridad en Transporte), que incluyen el sistema Travel Sentry el cual permite que el personal de seguridad de los aeropuertos examine el contenido del equipaje sin forzar el candado o dañar la maleta.

Yale offers padlocks with a wide variety of designs for different uses and conditions. The product range goes from the outdoor series to the highly recognized Italian Series. On the other hand, in search for innovating and satisfying all the highest security requirements, the brand introduces the Swedish Series, cables for portable security and the traveling series.

The traveling series includes the TSA (Transportation Security Administration) padlocks, which includes the Travel Sentry system which allows the security personnel to examine the luggage content without forcing the padlock or damaging the luggage.

GLOSARIO

Glossary

Características / Features:

Gancho en acero endurecido Hardened steel shackle	Gancho en acero al Boro Hardened steel Boron shackle	Retención de llave Key retention	2 llaves 2 keys	3 llaves 3 keys	Tres llaves Three keys	3 pines 3 pins	4 pines 4 pins	
5 pines 5 pins	6 pines 6 pins	llaves igualdas one key fits all	Anti-segueta Anti-saw	Anti-ganzúa Anti-pick	Anti-cizalla Bolt cutter resistant	Condiciones extremas Extreme conditions	Condiciones marinas Marine conditions	
Resistente a la intemperie Weather resistant	Doble bloqueo por esferas Double ball locking	Doble bloqueo Double locking	Gancho protegido Covered shackle					



SERIE INTEMPERIE

Outdoor series



SKU	DESCRIPCIÓN / DESCRIPTION
0002041	Cad 800 Inte Amari 50mm
0002044	Cad 800 Inte Amari 50mm B
0002042	Cad 800 Inte Azul 50mm
0002043	Cad 800 Inte R 50mm
0002047	Cad 800 Inte Amari 70mm
0002050	Cad 800 Inte Amari 70mm B
0002071	Cad 800 Inte Amari 70mm P
0002048	Cad 800 Inte Azul 70mm
0002049	Cad 800 Inte R 70mm

	MEDIDAS EN mm. / MEASURES IN mm.				
	A	B	C	D	E
50	61	50	23	37	12
70	75	53	30	42	14

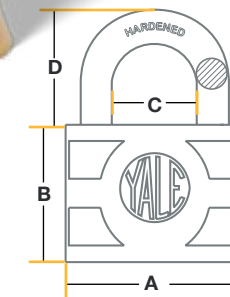

Candado Alemán intemperie / Weather resistant German padlock

- Gancho en acero endurecido
- La llave se libera solamente cuando el candado está cerrado
- Resistente a la intemperie para usos en exteriores
- Cuerpo en latón fundido
- Cubierta en PVC
- Hardened steel shackle
- The key is released only when the lock is closed
- Weather-resistant padlock suitable for outdoor applications
- PVC cover



Candado serie 220 / Padlock series 220

- Gancho en acero endurecido
- Ranura de llave cubierta para evitar el óxido
- Resistente a la intemperie para usos en exteriores
- Doble bloqueo con esferas
- Hardened steel shackle
- Keyway cover cap to prevent rusting
- Weather-resistant suitable for outdoor applications
- Double ball bearing lock for added security



SKU	DESCRIPCIÓN / DESCRIPTION
0008815	Cad 220 Inte 51mm B
0008816	Cad 220 Inte 61mm B
0008817	Cad 220 Inte 71mm B

	MEDIDAS EN mm. / MEASURES IN mm.				
	A	B	C	D	E
51	51	49	17	22	6
61	61	54	20	26	9,5
71	71	59	26	31	11

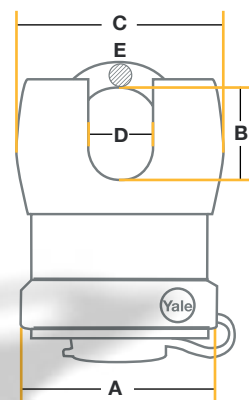

Candado serie 221 / Padlock series 221

- Gancho protegido en acero endurecido
- Ranura de llave cubierta para evitar óxido
- Resistente a la intemperie para usos en exteriores
- Doble bloqueo con esferas
- Hardened steel shackle
- Keyway cover cap to prevent rusting
- Weather-proof padlock suitable for outdoor applications
- Double ball bearing lock for added security

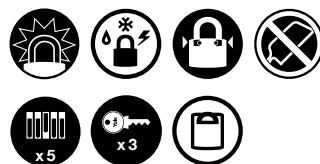

SKU	DESCRIPCIÓN / DESCRIPTION
0008504	Cad 221 Inte 52mm B
0008505	Cad 221 Inte 61mm B

MEDIDAS EN mm. / MEASURES IN mm.					
	A	B	C	D	E
52	52	25	55	18	9
61	61	28	64	20	11

SERIE ITALIANA

Italian Series

Candado Italiano 110 / Italian padlock 110

- Gancho en acero endurecido
- Protector contra filtraciones de agua
- Doble bloqueo
- Anti-segueta
- Hardened steel shackle
- Plastic gasket against water filtration
- Double locking
- Anti-saw



SKU	DESCRIPCIÓN / DESCRIPTION
0001101	Cad 110 30mm C
0001102	Cad 110 40mm C
0001103	Cad 110 50mm C
0001104	Cad 110 60mm C
0001105	Cad 110 70mm C

SKU	DESCRIPCIÓN / DESCRIPTION
0010563	Cad 110 20mm B
0010564	Cad 110 25mm B
0001106	Cad 110 30mm B
0001107	Cad 110 40mm B
0001108	Cad 110 50mm B
0001109	Cad 110 60mm B
0001110	Cad 110 70mm B

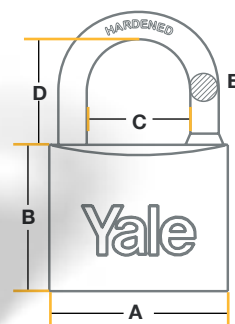

MEDIDAS EN mm. / MEASURES IN mm.						
	A	B	C	D	E	Pines / Pins
20	20	21	11	11	3,3	4
25	25	24	13	14	4,3	4
30	30	27	15	16	5	4
40	40	33	21	22	6	5
50	50	39	26	25	8	6
60	60	45	31	32	10	6
70	70	51	37	37	11	6



Candado Italiano 110-40 igualado por 2 unidades / Italian padlock 110-40 2 unit keyed alike

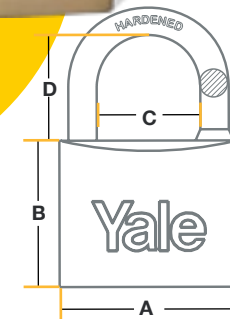

- Gancho en acero endurecido
- Doble bloqueo
- Anti-segueta
- 3 llaves
- Hardened steel shackle
- Double locking
- Anti-saw
- 3 keys



SKU	DESCRIPCIÓN / DESCRIPTION
0001132	Cad 110 Igua 2 40mm B

MEDIDAS EN mm. / MEASURES IN mm.						
	A	B	C	D	E	Pines / Pins
40	40	33	21	22	6	5

Candado Y110 gancho protegido / Padlock Y110 protected shackle

- Gancho en acero endurecido
- Cuerpo en latón sólido
- Gancho protegido
- Hardened steel shackle
- Solid brass body
- Protected shackle



MEDIDAS EN mm. / MEASURES IN mm.				
A	B	C	D	E
40	53	16	19	6

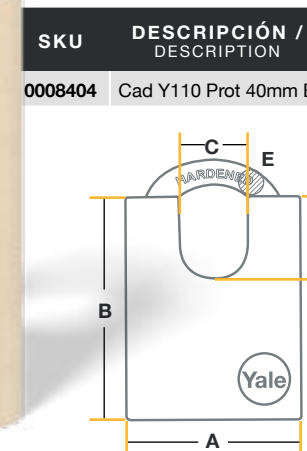

SKU	DESCRIPCIÓN / DESCRIPTION
0008404	Cad Y110 Prot 40mm B



SKU	DESCRIPCIÓN / DESCRIPTION
0008809	Cad Y110 Larg 40mm B

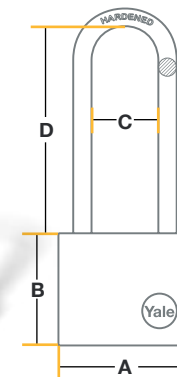

Candado Y110 gancho largo / Padlock Y110 long shackle

- Gancho en acero endurecido
- Doble bloqueo
- Anti-segueta
- Hardened steel shackle
- Double locking
- Anti-saw



MEDIDAS EN mm. / MEASURES IN mm.					
A	B	C	D	E	Pines / Pins
40	40	33	22	65	5

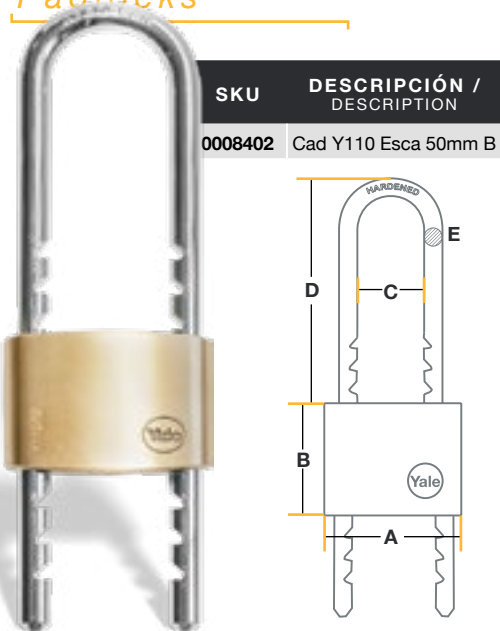

SKU	DESCRIPCIÓN / DESCRIPTION
0008402	Cad Y110 Esca 50mm B

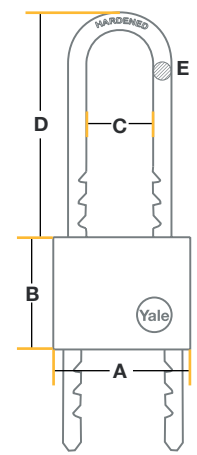

Candado Y110 gancho ajustable / Padlock Y110 adjustable shackle

- Gancho en acero endurecido
- Doble bloqueo
- Anti-segueta
- Hardened steel shackle
- Double locking
- Anti-saw

MEDIDAS EN mm. / MEASURES IN mm.						
	A	B	C	D	E	Pines / Pins
50	50	42	29	59/153	8	5



Candado Y110 igualado por 2 unidades / Padlock Y110 2 units keyed alike

- Gancho en acero endurecido
- Doble bloqueo
- Anti-segueta
- Hardened steel shackle
- Double locking
- Anti-saw

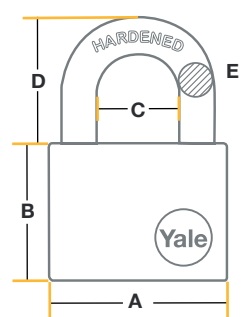

SKU	DESCRIPCIÓN / DESCRIPTION
0008401	Cad Y110 Iguá 2 30mm B

MEDIDAS EN mm. / MEASURES IN mm.						
	A	B	C	D	E	Pines / Pins
30	30	27	15	16	5	4



MEDIDAS EN mm. / MEASURES IN mm.					
	A	B	C	D	E
70	70	47	20	14	12
80	80	57	30	20	12
90	90	59	35	20	12

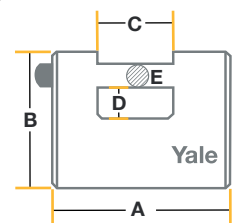

SKU	DESCRIPCIÓN / DESCRIPTION
0010718	Cad 162 70mm
0010719	Cad 162 80mm
0010720	Cad 162 90mm

Candado para cortina 162 / 162 curtain padlock

- Cuerpo en latón
- Cilindro en latón
- Gancho en acero endurecido
- 3 llaves
- Brass body
- Brass cylinder
- Hardened steel shackle
- 3 keys



MEDIDAS EN mm. / MEASURES IN mm.						
	A	B	C	D	E	Pines / Pins
30	30	19	14	11	5	3
40	40	25	22	22	6	4
50	50	27	25	24	8	4
60	60	30	30	30	10	5

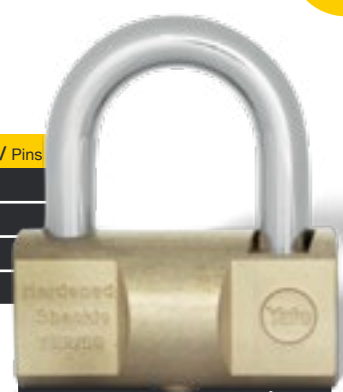
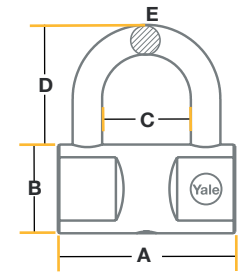

SKU	DESCRIPCIÓN / DESCRIPTION
0010473	Cad Barril 30mm B
0010474	Cad Barril 40mm B
0010475	Cad Barril 50mm B
0010476	Cad Barril 60mm B

Candado barrilito / Hammer padlock

- Gancho de acero endurecido
- Doble cerrojo
- Garantía de por vida
- Retiene llave cuando el candado está abierto (Referencias 50, 60 y 70mm)
- Hardened steel shackle
- Double locking
- Lifetime guarantee
- The key is released only when the lock is closed (only for 50, 60 and 70mm references)

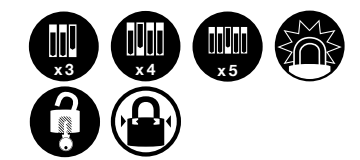

Candado serie 150 / Padlock series 150

- Gancho en acero
- 3 diales
- 4 diales en la referencia 40mm
- Steel shackle
- 3 dials
- 4 dials in 40mm model

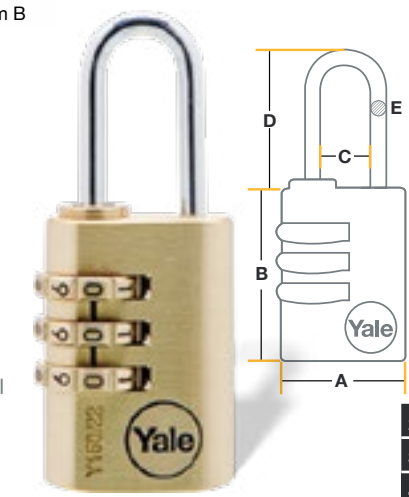

SKU	DESCRIPCIÓN / DESCRIPTION
0008409	Cad Y150 3Dial 22mm B
0008501	Cad Y150 3Dial 30mm B
0008502	Cad Y150 4Dial 40mm B

MEDIDAS EN mm. / MEASURES IN mm.					
	A	B	C	D	E
22	22	32	8	21	3
30	31	41	14	26	4
40	40	48	19	28	6

SERIE ALEMANA German Series

Candado Alemán 800 / German padlock 800

- Gancho en acero endurecido
- Doble bloqueo
- Anti-segueta
- Retiene la llave cuando el candado está abierto
- Hardened steel shackle
- Double locking
- Anti-saw
- The key is released only when the lock is closed

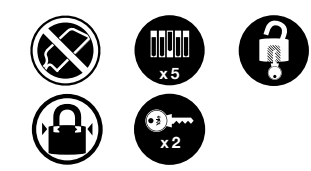

MEDIDAS EN mm. / MEASURES IN mm.					
	A	B	C	D	E
840	49	46	20	24	8
850	53	47	24	25	10
870	66	50	30	34	11

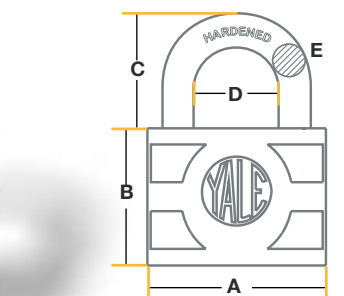

SKU	DESCRIPCIÓN / DESCRIPTION
0002001	Cad 800 40mm
0002002	Cad 800 50mm
0002003	Cad 800 70mm
0002011	Cad 800 40mm B
0002012	Cad 800 50mm B
0002013	Cad 800 70mm B

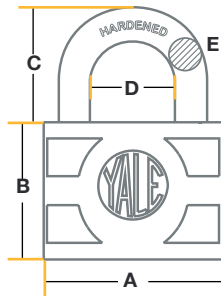

Candado Alemán 800 Plus / German padlock 800 Plus

- Gancho en acero endurecido
- Doble bloqueo
- Anti-segueta
- Retiene la llave cuando el candado está abierto
- Hardened steel shackle
- Double locking
- Anti-saw
- The key is released only when the lock is closed

MEDIDAS EN mm. / MEASURES IN mm.

	A	B	C	D	E
870	66	50	30	34	11

SKU	DESCRIPCIÓN / DESCRIPTION
0002070	Cad 800 70mm Plus
0002072	Cad 800 70mm Plus B



Candado Alemán 800 igualado por 2 y por 3 / German padlock 800 2 or 3 units keyed alike

- Gancho en acero endurecido
- Doble bloqueo
- Anti-segueta
- Retiene la llave cuando el candado está abierto
- 3 llaves en referencia igualado por 2 y 4 llaves en referencia igualado por 3
- Hardened steel shackle
- Double locking
- Anti-saw
- The key is released only when the lock is closed
- 3 keys for 2 units keyed alike reference and 4 keys for 3 units keyed alike reference

MEDIDAS EN mm. / MEASURES IN mm.

	A	B	C	D	E
850	53	47	24	25	10
870	66	50	30	34	11

SKU	DESCRIPCIÓN / DESCRIPTION
0002007	Cad 800 Igualado 2 50mm
0002009	Cad 800 Igualado 2 70mm
0002008	Cad 800 Igualado 3 50mm
0002010	Cad 800 Igualado 3 70mm

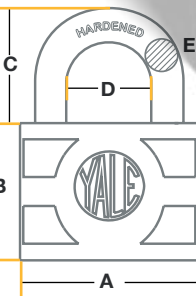
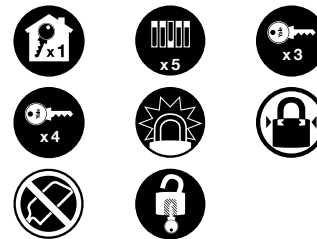
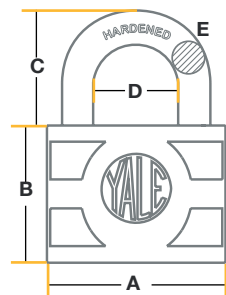

Candado Alemán Negro y gris / Grey & black German padlock

- Gancho en acero endurecido
- Doble bloqueo
- Anti-segueta
- Retiene la llave cuando el candado está abierto
- Colores gris y negro
- Hardened steel shackle
- Double locking
- Anti-saw
- The key is released only when the lock is closed
- Colors: grey & black

MEDIDAS EN mm. / MEASURES IN mm.

	A	B	C	D	E
840	49	46	20	24	8
850	53	47	24	25	10
870	66	50	30	34	11

SKU	DESCRIPCIÓN / DESCRIPTION
0002060	Cad 800 70mm Negro C
0002062	Cad 800 70mm Gris C
0002063	Cad 800 50mm Negro C
0002064	Cad 800 50mm Gris C
0002065	Cad 800 40mm Negro C
0002066	Cad 800 40mm Gris C



SERIE INGLESA
English Series

Candado Inglés 770 / English padlock 770

- 5 pines
- Doble bloqueo con esferas en acero endurecido
- 2 llaves
- Retiene la llave cuando el candado está abierto
- 5 pins
- Double hardened steel balls locking
- 2 keys
- The key is released when the padlock is closed

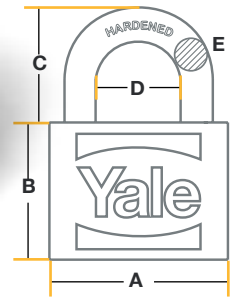
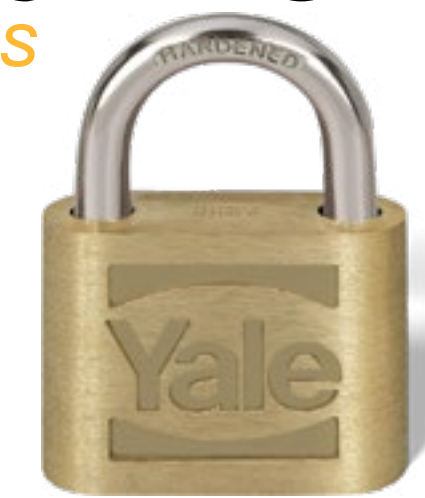

MEDIDAS EN mm. / MEASURES IN mm.

	A	B	C	D	E
740	49	47	32	24	8
750	53	48	36	26	10
770	66	51	41	34	11

SKU	DESCRIPCIÓN / DESCRIPTION
0002075	Cad 700 70mm
0002076	Cad 700 50mm C
0002077	Cad 700 40mm C





SERIE SUECA

Swedish Series



Candado serie sueca 120 / 120 swedish series padlock

- Gancho en acero al boro
- Doble bloqueo
- Acabado en cromo satinado
- Anti-segueta
- Resistente a la intemperie
- Hardened steel boron shackle
- Double locking
- Satin chrome finish
- Anti-saw
- Weather-resistant

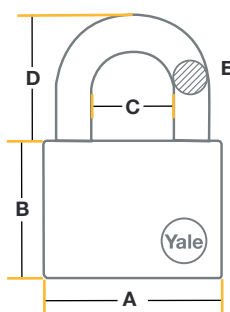

MEDIDAS EN mm. /
MEASURES IN mm.

	A	B	C	D	E
40	40	37	20	25	7
50	50	46	25	26	9
60	60	65	34	34	10
70	70	52	40	41	11

SKU	DESCRIPCIÓN / DESCRIPTION
0010437	Cad 120 40mm B
0010438	Cad 120 50mm B
0010439	Cad 120 60mm B
0010440	Cad 120 70mm B



Candado serie Sueca 124 / Swedish padlock series 124

- Gancho en acero al boro
- Acabado en cromo satinado
- Anti-segueta
- Anti-cizalla
- Resistente a la intemperie
- Hardened steel boron shackle
- Satin chrome finish
- Anti-saw
- Bolt cutter resistant
- Weather-resistant

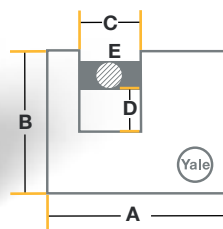

MEDIDAS EN mm. /
MEASURES IN mm.

	A	B	C	D	E
60	60	45	18	10	10
70	70	55	22	15	12

SKU	DESCRIPCIÓN / DESCRIPTION
0008406	Cad Y124 Cortina 60mm B
0008407	Cad Y124 Cortina 70mm B



Candado acorazado 161 / Armored padlock 161

- Gancho en acero endurecido
- Acorazado en acero inoxidable
- Anti-segueta
- Contra la intemperie
- Retiene la llave con el candado abierto
- Hardened steel shackle
- Stainless steel armor
- Anti-saw
- Weather-resistant
- Key retention in the unlocked position

	A	B	C	D	E
70	71	61	25	13	10
80	82	64	30	17	11

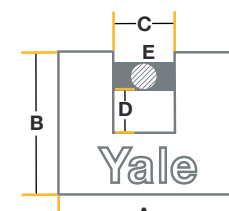

SKU	DESCRIPCIÓN / DESCRIPTION
0010630	Cad 161 Acorazado 80mm
0010976	Cad 161 Acorazado 90mm



SERIE LAMINADA

Laminated Series

Candado laminado 115 / Laminated padlock 115

- Gancho en acero endurecido
- Cuerpo laminado en acero zincado
- 30mm
- Hardened steel shackle
- Laminated steel zinc body
- 30mm

SKU	DESCRIPCIÓN / DESCRIPTION
0008405	Cad Y115 Lami 30mm B

	A	B	C	D
	34	26	14	18

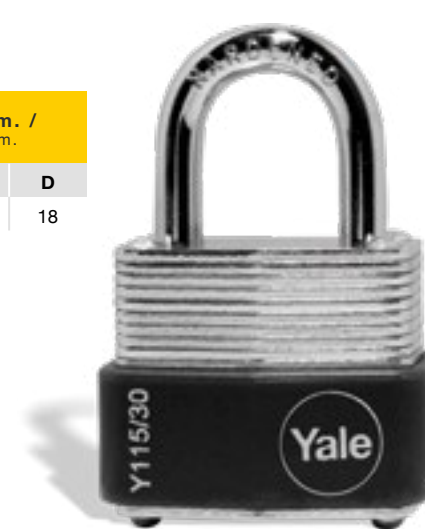
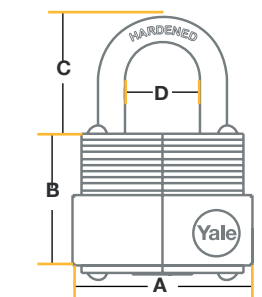

	A	B	C	D	E
40	44	36	20	25	6,4
50	54	38	23	29	9,5

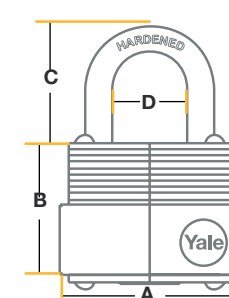

Candado laminado 125 / Laminated padlock 125

- Candado con cuerpo laminado en acero zincado
- Gancho en acero endurecido
- Doble bloqueo con esferas
- Laminated zinc body
- Hardened steel shackle
- Double ball bearing lock for added security

SKU	DESCRIPCIÓN / DESCRIPTION
0008408	Cad Y125 Lami 40mm B
0008514	Cad Y125 Lami 50mm B





**Candado laminado 125
igualado por 2 unidades /
2 laminated padlocks 125
keyed alike**

- Candado con cuerpo laminado en acero zincado
- Gancho en acero endurecido
- Doble bloqueo con esferas
- Laminated zinc steel body
- Hardened steel shackle
- Double ball bearing lock for added security

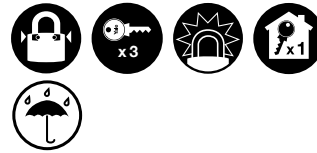

MEDIDAS EN mm. / MEASURES IN mm.					
A	B	C	D	E	
50	54	38	23	29	9,5

SKU	DESCRIPCIÓN / DESCRIPTION
0008511	Cad Y125 Lami Ig 2 50mm B



**Candado TSA YTP3 /
TSA padlock YTP3**



SKU	DESCRIPCIÓN / DESCRIPTION
0008826	Cad YTP3 Cable Cr TSA B

- Candados con cuerpo en zinc y gancho en alambre de acero de 11cms de largo
- 3 diales ajustables fáciles de usar
- Autorizados por TSA®.
- Padlock with zinc body and steel wire 11cms long
- 3 resetable dials easy to use
- Authorized by TSA®

**Candado TSA YTP2 /
TSA padlock YTP2**

SKU	DESCRIPCIÓN / DESCRIPTION
0008818	Cad YTP2 Rojo TSA B
0008820	Cad YTP2 Amar TSA B
0008821	Cad YTP2 Azul TSA B



- Candado con cuerpo y gancho en zinc
- 3 diales ajustables fáciles de utilizar
- Autorizados por TSA®.
- Padlock with zinc body and hook
- 3 resetable dials easy to use
- Authorized by TSA®

SERIE ALUMINIO
Aluminium Series

**Candados Aluminio YE3 /
Aluminium YE3 padlocks**

- Cuerpo en aluminio
- Gancho endurecido*
- 3 llaves
- Aluminium body
- Hardened shackle*
- 3 keys



MEDIDAS EN mm. / MEASURES IN mm.					
	A	B	C	D	E
25	28	24	12,7	18,2	4,3
32	35	30	16,7	21,2	5,3
38	42	34	19,7	27,6	6,3
50	50	41	26	34	8

SKU	DESCRIPCIÓN / DESCRIPTION
0008855	Cad YE3 25mm Negro B
0008857	Cad YE3 25mm V B
0008861	Cad YE3 25mm Fucsia B
0008858	Cad YE3 32mm Negro B
0008860	Cad YE3 32mm V B
0008856	Cad YE3 32mm Fucsia B
0008854	Cad YE3 38mm Negro B
0008859	Cad YE3 50mm Negro B

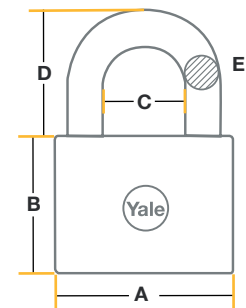

*Para referencias 32, 38 y 50mm / *For 32, 38 and 50mm references

SERIE COMBINACIÓN
Combination Series

**Candado de combinación serie YP1 /
Combination padlock series YP1**



- Cuerpo en metal sólido
- 3 diales ajustables
- Solid metal body
- 3 resetable dials

SKU	DESCRIPCIÓN / DESCRIPTION
0008824	Cad YP1 Rojo B
0008825	Cad YP1 Amar B



Candado de combinación serie YP2 /
Combination padlock series YP2

- Cuerpo en metal sólido
- 3 diales ajustables
- Solid metal body
- 3 resettable dials

SKU	DESCRIPCIÓN / DESCRIPTION
0008506	Cad YP2 Gris B
0008507	Cad YP2 Rojo B
0008828	Cad YP2 Amar B

SERVICIO DE AMAESTRAMIENTO

Master Key service

Disponible para candados serie Alemana e Italiana 110

Llave MK



¿Qué es un amaestramiento?

Un amaestramiento se refiere a un sistema en el cual una llave maestra opera todos los candados Yale y a su vez cada candado tendrá llaves individuales para su normal operación.

SKU	DESCRIPCIÓN / DESCRIPTION
0002121	Servicio de amaestramiento

Referencias 40, 50 y 70mm

Hasta 200 combinaciones con una llave MK

Referencia 50mm

Hasta 30 combinaciones con una llave MK



CANDADOS DE HIERRO

Iron padlocks

SKU	DESCRIPCIÓN / DESCRIPTION
0008852	Candado De Hierro 25mm
0008853	Candado De Hierro 32mm
0008844	Candado De Hierro 38mm
0008847	Candado De Hierro 45mm
0008846	Candado De Hierro 50mm
0008845	Candado De Hierro 63mm
0008848	Candado De Hierro 38mm B
0008851	Candado De Hierro 45mm B
0008850	Candado De Hierro 50mm B
0008849	Candado De Hierro 63mm B

Candado de hierro / Iron padlock

- Doble cerrojo, mayor resistencia al impacto
- Gancho de acero endurecido
- Cuerpo de hierro
- Double locking, better impact resistance
- Hardened steel shackle
- Iron body

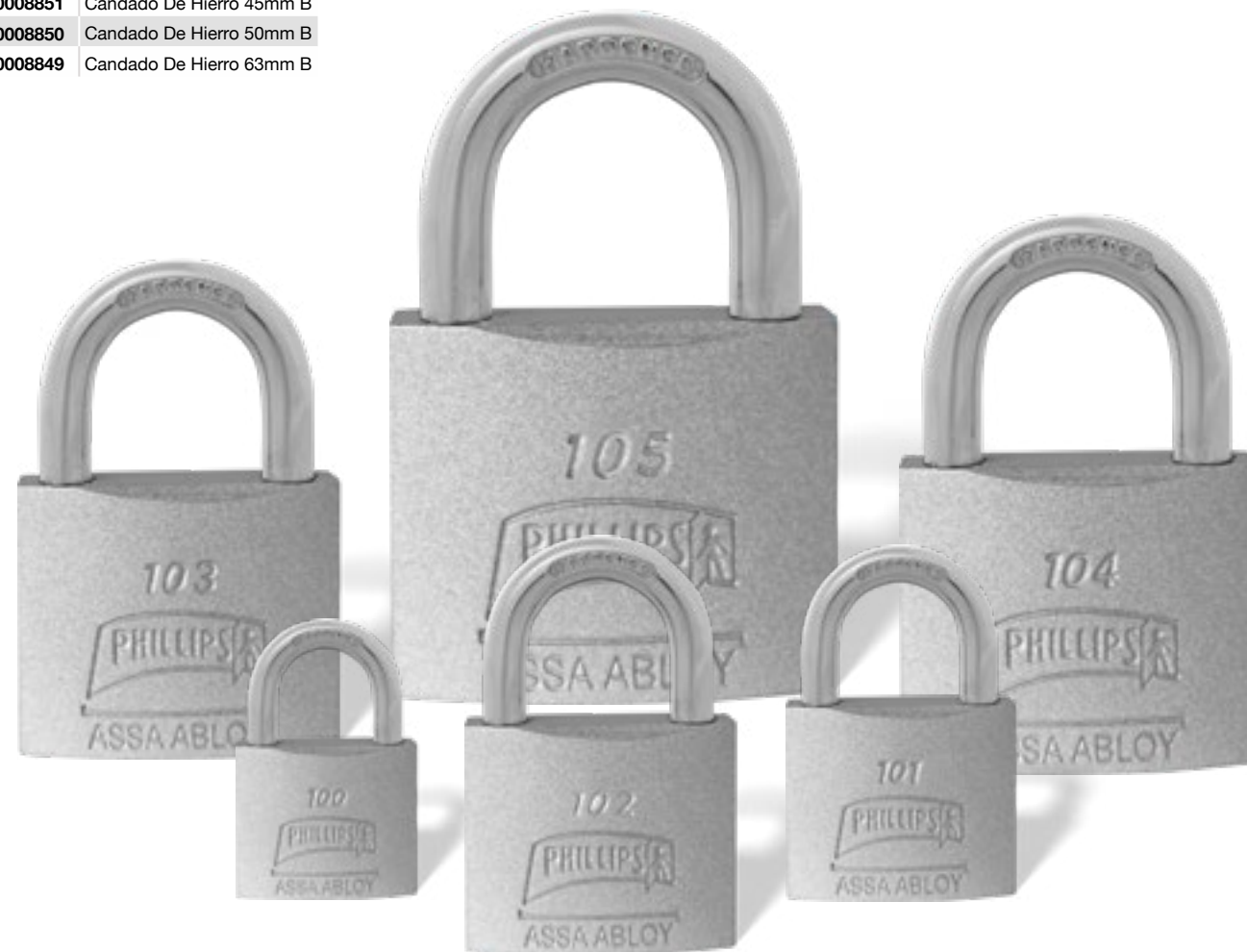

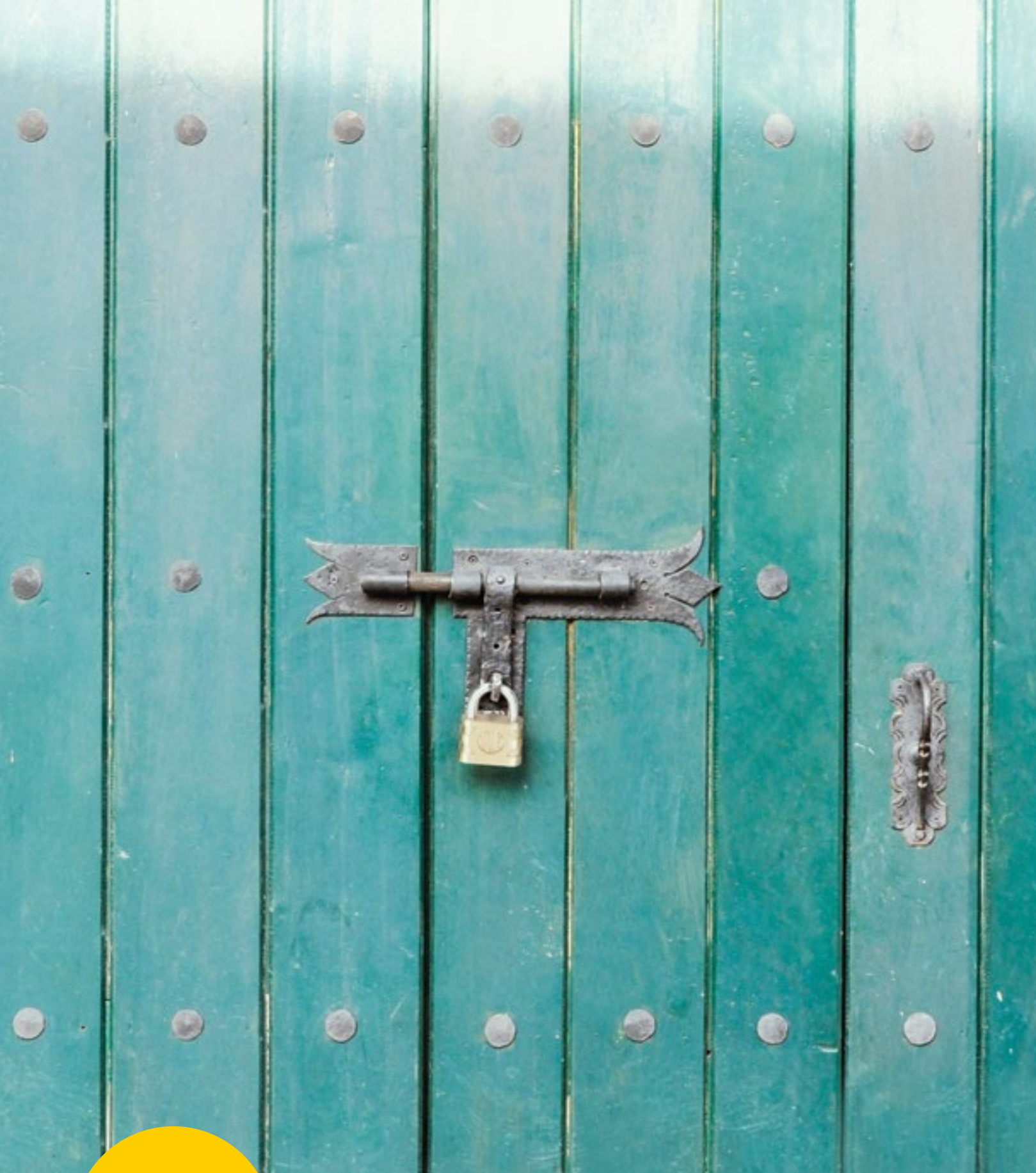

Toda una historia protegiendo los **hogares Colombianos**

Puerta colonial, Villa de Leyva, Boyacá



Ref: Barra antipánico Orlando

INSTITUCIONAL
Institutional

La línea institucional Yale está compuesta por una amplia gama de productos diseñados para solucionar las necesidades de acceso en áreas de alto tráfico.

Productos

Cierrapuertas:

Estos dispositivos son útiles para lugares en donde es necesario mantener la puerta cerrada, como una forma de ahorro de energía para lugares con aire acondicionado / calefacción o el cumplimiento de las normas para una puerta corta fuego. Al controlar la velocidad de la puerta, estos productos también ayudan al acceso de personas discapacitadas a una locación.

Barra antipánico:

Cumple con los exigentes estándares de las normas y códigos para puertas contra fuego, conservando una exclusiva apariencia arquitectónica.

Yale's institutional line has a wide range of products designed to meet the needs of access in high traffic areas.

Products

Door closers:

These devices are suited for applications where it is necessary to maintain the door closed as a way to save energy costs in an air condition/heating space, or comply with fire and life safety building codes. By controlling the speed of the door, these products also helps disable people gain access into a location.

Exit device:

Meets the demanding regulation and codes for fire rated exit doors, keeping an exclusive architectural appearance.

GLOSARIO

Glossary

Acabados / Finishes:



US26D
Cromo satinado
/ Satin chrome



AI
Acero inoxidable
/ Stainless steel



Plata / Silver

Características / Features:



Instalación sencilla
Easy installation



Laboratorio Underwriters
Underwriters Laboratories



Instituto Nacional
Estadounidense
de Estándares
American National
Standards Institute



Conformidad Europea
European Conformity



Peso límite y fuerza
Weight limit and size

Abreviatura / Abbreviation:

Cie puertas:
Cierrapuertas
/ Doorcloser

Combo: Combo
/ Combo

Antipani: Antipánico
/ Exit device

Senci: Sencillo
/ Single

Doble: Doble
/ Double

HO: Mantiene puerta abierta
/ Hold open

B: Empaque blister
/ Visual pack

CIERRAPUERTAS AÉREOS

Surface door closers

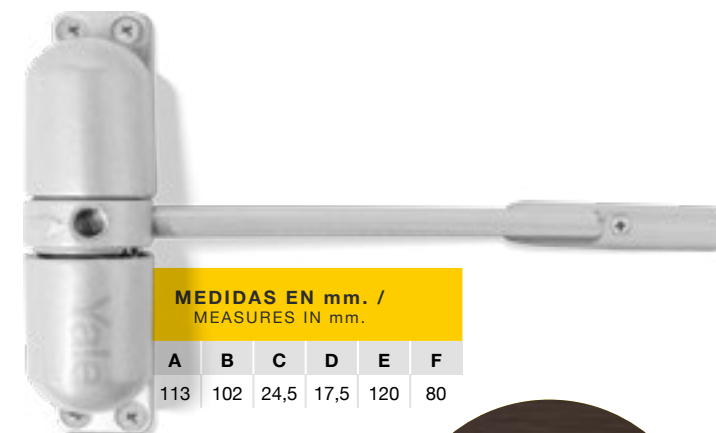

MEDIDAS EN mm. / MEASURES IN mm.

A	B	C	D	E	F
113	102	24,5	17,5	120	80

SKU	DESCRIPCIÓN / DESCRIPTION
0007056	Cie Puerta Instfacil Plata

Ejemplo de instalación

Instalafácil / Easy fit

- Para puertas de hasta 65 kg, derechas o izquierdas
- Fuerza ajustable
- Mecanismo resortado
- For right or left handed doors up to 143.3lbs
- Adjustable size
- sprung mechanism

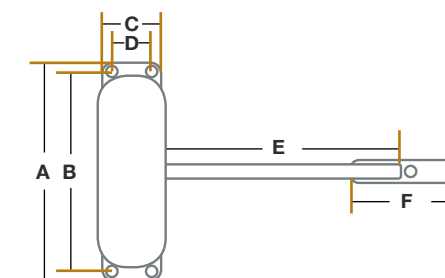

Serie 1002 / 1002 Series

- Para puertas hasta 45 kg
- Fuerza 2
- Permite apertura hasta 150°
- Dos válvulas independientes para control de velocidad inicial y de cierre final
- For doors up to 100lbs
- Size 2
- Allows 150° opening
- Two independent valves to control sweep and latch speed

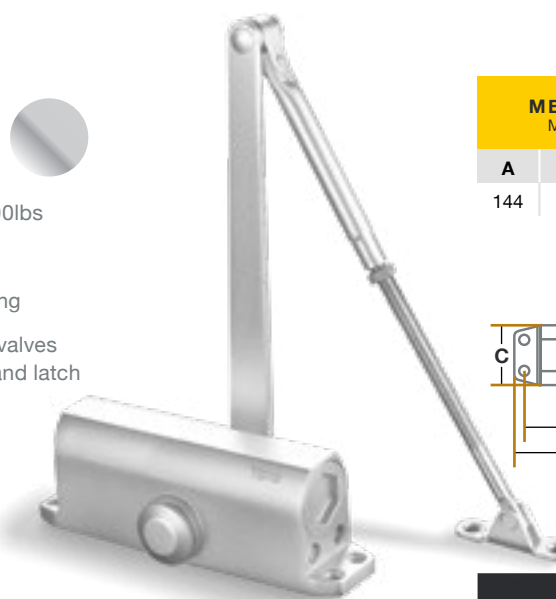

MEDIDAS EN mm. / MEASURES IN mm.

A	B	C	D	E
144	132	36	19	45

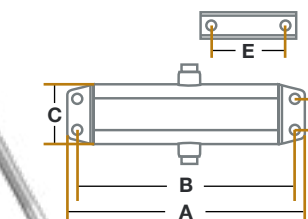

SKU	DESCRIPCIÓN / DESCRIPTION
0007018	Cie puertas 1002 Plata
0001513	Cie puertas 1002 Plata B

SKU	DESCRIPCIÓN / DESCRIPTION
0008320	Cie puertas 2234 Plata
0001524	Cie puertas 2234 Plata B
0008321	Cie puertas 2234 Plata HO

MEDIDAS EN mm. / MEASURES IN mm.				
A	B	C	D	E
220	202	52	19	45



Serie 2234 / 2234 Series

- Para puertas hasta 80 kg
- Fuerza ajustable 2-3-4
- Permite apertura hasta 180 °
- Dos válvulas independientes para control de velocidad inicial y de cierre final
- For doors up to 176lbs
- Adjustable size 2-3-4
- Allows 180° opening
- Two independent valves to control sweep and latch speed



Serie 3005 / 3005 Series

- Para puertas hasta 150 kg
- Fuerza ajustable por regulación de resorte 1-6
- Permite apertura hasta 180 °
- Tres válvulas, dos para control de velocidad (inicial y cierre final) y una para control de apertura, ajustando freno hidráulico
- For doors up to 330lbs
- Adjustable size by spring regulation 1-6
- Allows 180° opening
- Three independent valves, two to control sweep and latch speed, and the third to control backcheck



SKU	DESCRIPCIÓN / DESCRIPTION
0007019	Cie puertas 3005 Plata

MEDIDAS EN mm. / MEASURES IN mm.				
A	B	C	D	E
246	230	44,5	19	44,5

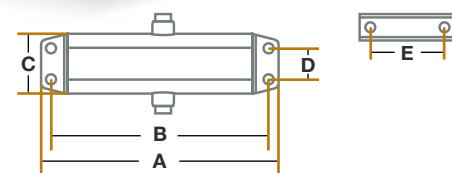

CIERRAPUERTAS DE PISO

Floor door closer

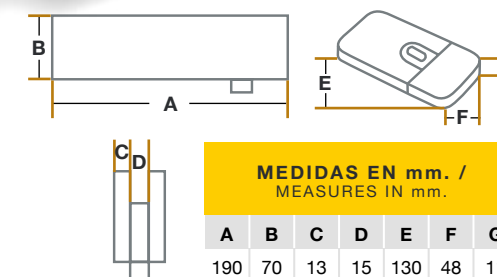

MEDIDAS EN mm. / MEASURES IN mm.						
A	B	C	D	E	F	G
190	70	13	15	130	48	11

Y1000

- Cuerpo en aluminio
- Para puertas de vidrio interiores de máximo 110cm de ancho, con un peso máximo de 100kg
- Mantiene la puerta abierta a 90°
- Máxima apertura: 130°
- Dos válvulas para control de velocidad de cierre inicial y final
- Fácil instalación sin necesidad de abrir hueco en el piso
- Aluminum body
- For interior glass doors with 43.3in (110cm) maximum width and 220.4lb (100kg) maximum weight.
- Keeps the door open to 90°
- 130° maximum opening angle
- Two valves to control sweep and latch speed
- Easy to install without making a hole in the floor

SKU	DESCRIPCIÓN / DESCRIPTION
0007027	Cie puertas Y1000 vidrio

Y90

- Para puertas de aluminio, vidrio, metal y madera
- Múltiples combinaciones de regulación gracias a sus 11 puntos de ajuste; horizontal, longitudinal y vertical
- Fuerza de 120 kilos
- Mantiene la puerta abierta a 90°.
- Ancho máximo puerta interior: 1200mm
- Ancho máximo puerta exterior: 1000mm
- Fuerza de apertura menor a 60Nm - fuerza de cierre menor a 35 Nm
- For aluminum, glass, metal and wood doors
- Multiple combination adjustment given by 11 adjustment points
- 240lb force
- Keeps the door open to 90°.
- Maximum width inner door: 1200mm
- Maximum wide exterior door: 1000mm
- Strength Low-60Nm opening - closing force of less than 35 Nm

SKU	DESCRIPCIÓN / DESCRIPTION
0008841	Cie puertas piso Y90
0007034	Combo Cie piso Y90 pivote

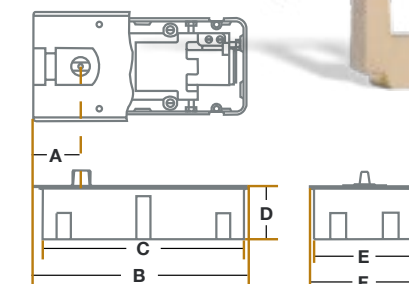

MEDIDAS EN mm. / MEASURES IN mm.					
A	B	C	D	E	F
65	292	270	50	123	149



BARRAS ANTIPÁNICO

Exit devices

Barra Antipánico Orlando 1 y 2 puntos / 1 & 2 points Orlando exit device

- Barra antipánico tipo cross bar
- Disponible con 1 punto y 2 puntos de cierre
- CE 60 minutos cortafuego
- Largo de barra: 130cm ajustable
- Para puertas de hasta 340cm de altura (barra de 2 puntos)
- Utiliza manija Orión
- Cross bar type device
- Available for 1 and 2 closing points
- CE 1 hour fire rated
- Length: 130cm adjustable
- Height: Up to 340cm (2 points device)
- Uses Orión lever

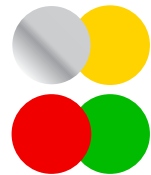

SKU	DESCRIPCIÓN / DESCRIPTION
0007134	Barra Anti Orlando 1P R
0007137	Barra Anti Orlando 2P R
0007132	Barra Anti Orlando 1P V
0007135	Barra Anti Orlando 2P V
0007133	Barra Anti Orlando 1P A
0007136	Barra Anti Orlando 2P A
0035017	Barra Anti Orlando 1P P
0035016	Barra Anti Orlando 2P P

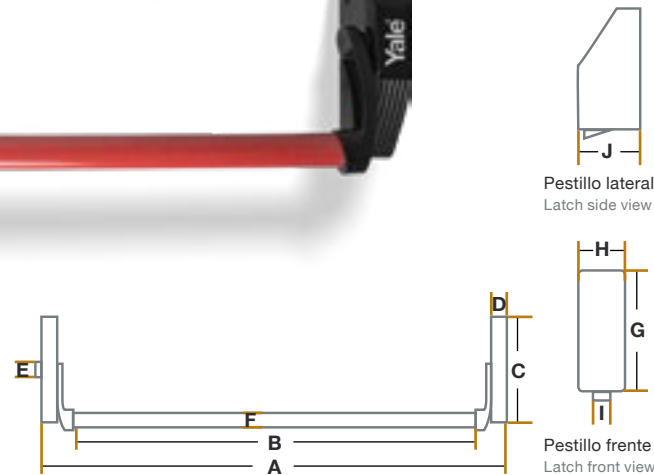

MEDIDAS EN mm. / MEASURES IN mm.					
A	B	C	D	E	F
1400	1300	208	40	25	29

MEDIDAS EN mm. / MEASURES IN mm.				
G	H	I	J	
140	39	19	50	



Barra antipánico Tampa 1 y 2 puntos / 1 & 2 points Tampa exit device

- UL 3 horas contra fuego
- ANSI grado 1
- Acabado plata
- Chasis en acero y tapas en zinc
- Longitud: 100cm. Se puede cortar a 60cm
- *Barra de 2 puntos Altura estándar 210cm
- Utiliza manija Eiffel o Versailles para madera y metal
- UL 3 hour fire rated
- ANSI grade 1
- Silver finish
- Steel body and zinc caps
- Length: 100cm. Can be shortened to 60cm
- *2 points device Standar height: 210cm
- Uses Eiffel or Versailles lever for wood and metal



SKU	DESCRIPCIÓN / DESCRIPTION
0035010	Barra Antipani Tampa 1Pt
0035011	Barra Antipani Tampa 2Pt

MEDIDAS EN mm. / MEASURES IN mm.

A	B	C	D	E	F	G
50	25	426	500	154	24	40

MEDIDAS EN mm. / MEASURES IN mm.

H	I	J	K	L
62	40,8	23	10,3	28,5

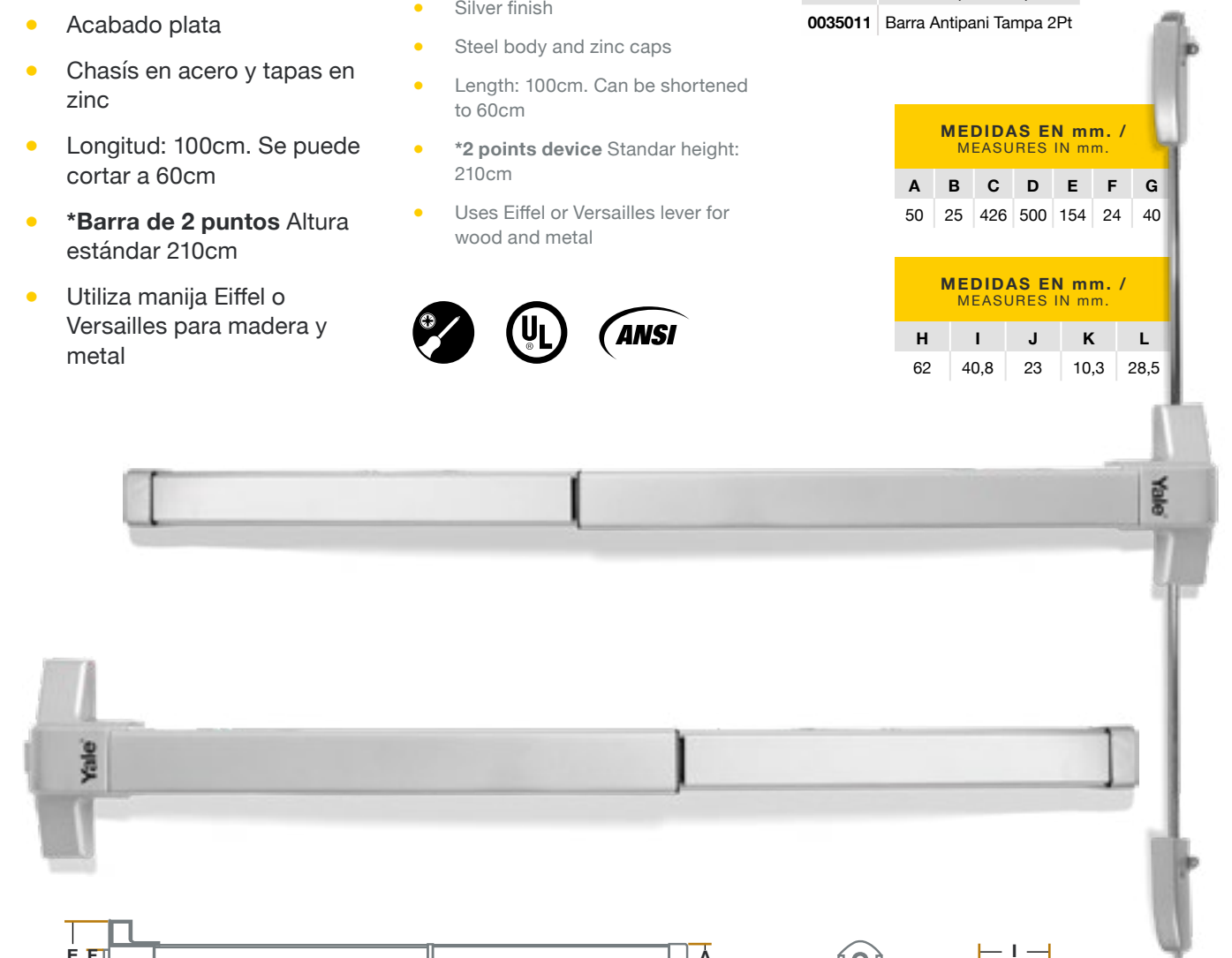

Contra superior
Upper strike

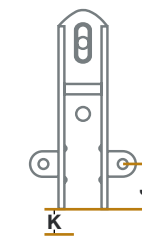

Pestillo inferior
Lower latch

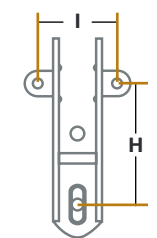

Pestillo superior
Upper latch

Barra antipánico Tampa acero inoxidable 1 y 2 puntos / 1 & 2 points stainless steel Tampa exit device

- UL 3 horas contra fuego.
- ANSI grado 1.
- Acabado acero inoxidable.
- Chasis y tapas en acero inoxidable 304.
- Longitud 100cm; se puede cortar a 60cm.
- ***Barra de 2 puntos** Altura estándar 210cm
- Utiliza manija Eiffel o Versailles para madera y metal
- UL 3 hour fire rated
- ANSI grade 1
- Stainless steel finish
- 304 stainless steel body and caps
- Length: 100cm. Can be shortened to 60cm
- ***2 points device** Standar height: 210cm
- Uses Eiffel or Versailles lever for wood and metal



SKU	DESCRIPCIÓN / DESCRIPTION
0035021	Barra Anti Tampa Inox 1Pt
0035020	Barra Anti Tampa Inox 2Pt

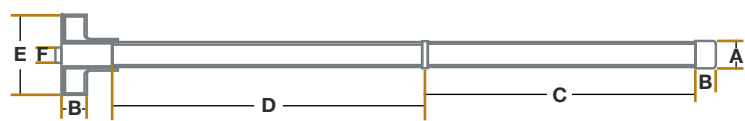

MEDIDAS EN mm. / MEASURES IN mm.						
A	B	C	D	E	F	G
50	25	426	500	154	24	40

MEDIDAS EN mm. / MEASURES IN mm.					
H	I	J	K	L	
62	40,8	23	10,3	28,5	

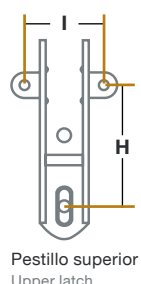
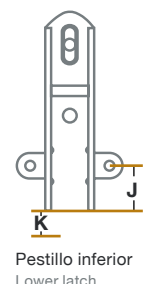
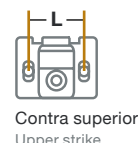

Barra antipánico Tampa para puertas de vidrio 2 puntos / 2 points glass doors Tampa exit device

- UL 3 horas contra fuego
- ANSI grado 1
- Acabado plata
- Chasis en acero y tapas en zinc
- Longitud: 100cm. Se puede cortar a 60cm
- ***Barra de 2 puntos** Altura estándar 210cm
- Incluye 7 topos de fijación y 3 placas decorativas
- Utiliza manija Versailles
- UL 3 hour fire rated
- ANSI grade 1
- Silver finish
- Steel body and zinc caps
- Length: 100cm. Can be shortened to 60cm
- ***2 points device** Standar height: 210cm
- 7 fixing accessories and 3 decorative shields included
- Uses Versailles lever



SKU	DESCRIPCIÓN / DESCRIPTION
0035014	Barra Anti Tampa Vid 2Pt

MEDIDAS EN mm. / MEASURES IN mm.					
A	B	C	D	E	F
50	25	426	500	154	40

MEDIDAS EN mm. / MEASURES IN mm.				
G	H	I	J	K
62	40,8	23	10,3	28,5



Barra antipánico con alarma / Exit device with alarm

- Acabado plata
- Chasis en acero y tapas en zinc
- Longitud: 100cm. Se puede cortar a 80cm
- Incluye alarma alimentación 9 Volt
- Salida contacto seco
- 1.000.000 de ciclos
- Silver finish
- Steel body and zinc caps
- Length: 100cm. Can be shortened to 80cm
- It includes alarm supply 9 Volt
- Dry contact output
- 1.000.000 de cycles



SKU	DESCRIPCIÓN / DESCRIPTION
0007049	Barra Antipani 1pt alarm

MEDIDAS EN mm. / MEASURES IN mm.

A	B	C	D	E	F	G
50	25	426	500	154	24	40

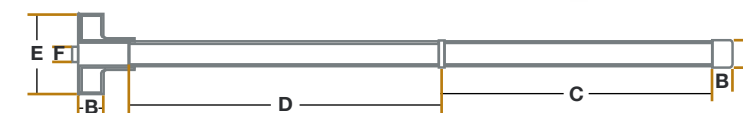



MEDIDAS EN mm. / MEASURES IN mm.

A	B	C	D
113	133	33	100

SKU DESCRIPCIÓN / DESCRIPTION

0007131	Manija Orión Negra
---------	--------------------

Manija Orión / Orión lever

- Manija para barra antipánico Orlando
- Acabado: negro
- 3 llaves
- Para puertas de 40 a 70mm de espesor
- Lever for Orlando exit device
- Black finish
- 3 keys included
- Door thickness: 40 to 70mm

Manija Eiffel / Eiffel Trim

- Manija para barra Tampa
- Cilindro con dos llaves
- Trim for Tampa exit device
- Cylinder with two keys

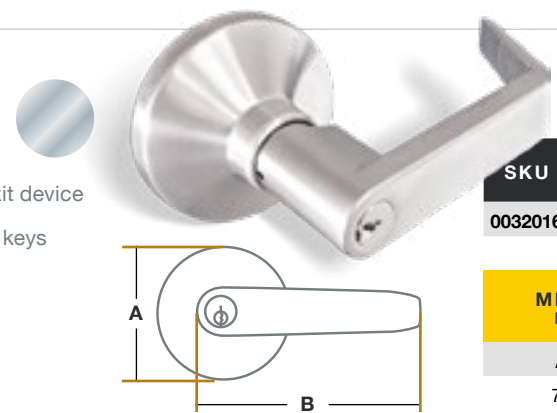

SKU	DESCRIPCIÓN / DESCRIPTION
0032016	Manija Eiffel US26D

MEDIDAS EN mm. / MEASURES IN mm.	
A	B
70	110



SKU	DESCRIPCIÓN / DESCRIPTION
0032017	Manija versailles madera -metal US26D
0032018	Manija versailles vidrio US26D

MEDIDAS EN mm. / MEASURES IN mm.			
A	B	C	D
145	123	49	137

Manija Versailles / Versailles lever

- Disponible en versión para puertas de madera / metal y para puertas de vidrio
- 3 llaves
- Available for wooden/metal and glass doors
- 3 keys

Jaladera y cilindro para barra antipánico / Pull and cylinder for exit device

- Cilindro en latón con 5 pines
- 3 llaves
- Jaladera y manija en acero inoxidable
- 5 pins brass cylinder
- 3 keys
- Stainless steel face plate and pull

SKU	DESCRIPCIÓN / DESCRIPTION
0035013	Jaladera y Cil para Antipa

MEDIDAS EN mm. / MEASURES IN mm.		
A	B	C
300	75	178

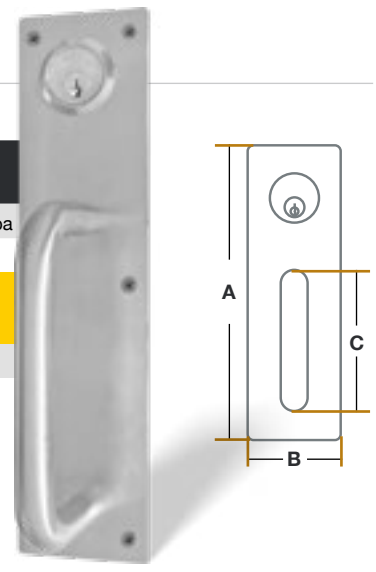

COMBOS Kits



Combo Tampa para vidrio + manija Versailles / Glass doors Tampa exit device + Versailles lever

- Barra Tampa de 2 puntos para vidrio
- Manija Versailles para puerta de vidrio
- 2 points glass door Tampa exit device
- Glass door Versailles lever



SKU	DESCRIPCIÓN / DESCRIPTION
0035015	Combo Senci vid man 2pts

Combo sencillo antipánico 1 punto / 1 point exit device single combo

- Una barra antipánico Tampa 1 punto
- Un cierrapuertas hidráulico serie 3005
- Una manija exterior Eiffel
- One Tampa 1 point exit device
- One 3005 series door closer
- One Eiffel trim



SKU	DESCRIPCIÓN / DESCRIPTION
0034900	Combo Senci Antipani 1Pt



Combo sencillo antipánico 2 puntos / 2 points exit device single combo

- Una barra antipánico Tampa 2 puntos
- Un cierrapuertas hidráulico serie 3005
- Una manija exterior Eiffel
- One Tampa 2 points exit device
- One 3005 series door closer
- One Eiffel trim



SKU	DESCRIPCIÓN / DESCRIPTION
0034902	Combo Senci Antipani 2Pt

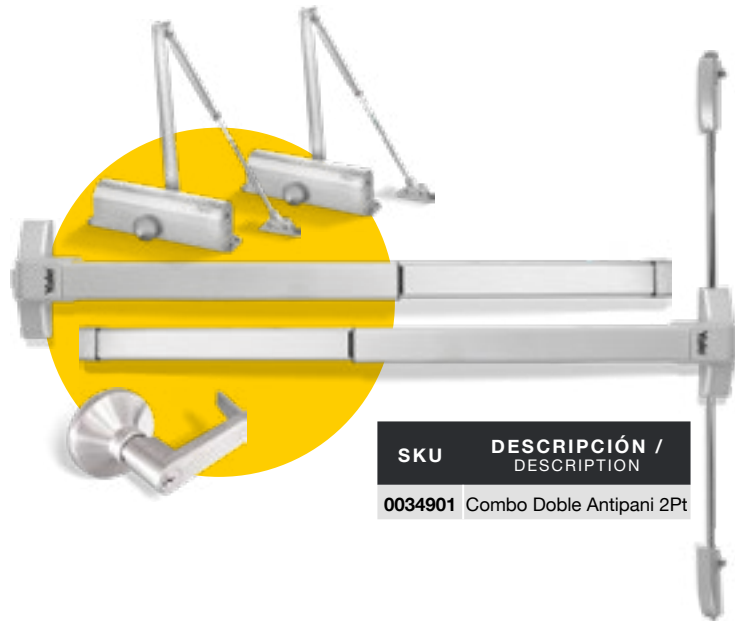

SKU	DESCRIPCIÓN / DESCRIPTION
0034901	Combo Doble Antipani 2Pt

Combo doble antipánico 2 puntos / 2 points exit device double combo

- Una barra antipánico Tampa 1 punto
- Una barra antipánico Tampa 2 puntos
- Dos cierrapuertas hidráulico serie 3005
- Una manija exterior Eiffel
- One Tampa 1 point exit device
- One Tampa 2 points exit device
- Two 3005 series door closer
- One Eiffel trim



Combo corta fuego 1 punto / 1 point fire rated combo

- Barra antipánico Tampa 1 punto
- Cierrapuertas 3005
- Manija Eiffel
- Sello perimetral negro 5.40 mt
- Bisagras MAC – PRO 4.5 X 4.5 26D
- One Tampa 1 point exit device
- One 3005 series door closer
- One Eiffel trim
- Perimetral gasketing 5.40mts
- Mac Pro hinge 4.5" x 4.5"



SKU	DESCRIPCIÓN / DESCRIPTION
0034907	Combo Senci Cortafue 1Pt

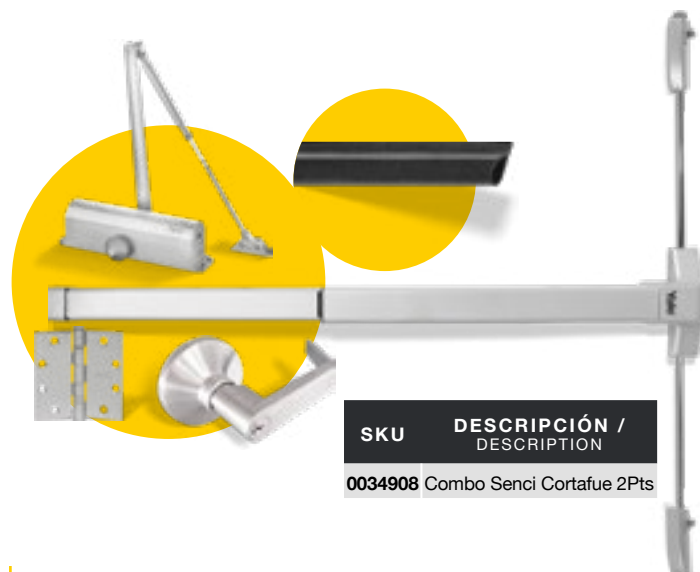

SKU	DESCRIPCIÓN / DESCRIPTION
0034908	Combo Senci Cortafue 2Pts

Combo corta fuego 2 puntos / 2 points fire rated combo

- Barra antipánico Tampa 2 puntos
- Cierrapuertas 3005
- Manija Eiffel
- Sello perimetral negro 5.40 mt
- Bisagras MAC – PRO 4.5 X 4.5 26D
- One Tampa 2 points exit device
- One 3005 series door closer
- One Eiffel trim
- Perimetral gasketing 5.40mts
- Mac Pro hinge 4.5" x 4.5"

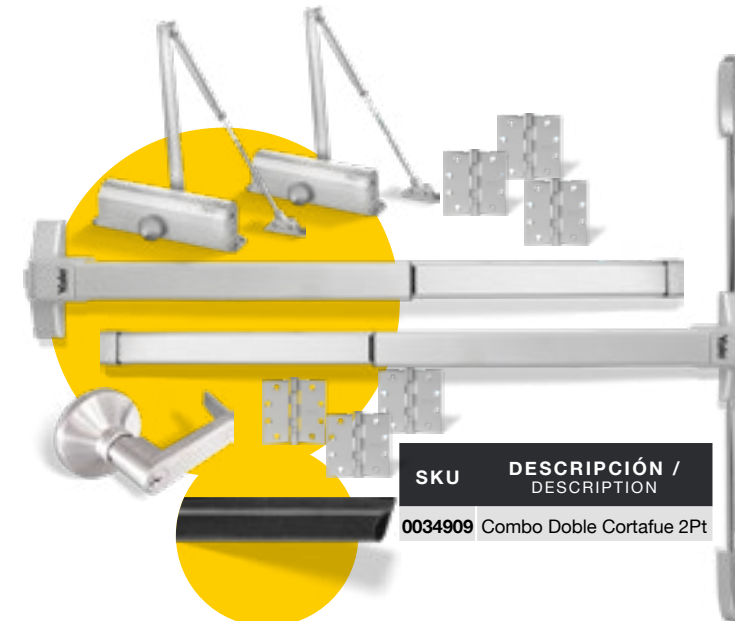

SKU	DESCRIPCIÓN / DESCRIPTION
0034909	Combo Doble Cortafue 2Pt

Combo doble corta fuego 2 puntos / 2 points fire rated double combo

- Barra antipánico Tampa 1 punto
- Barra antipánico Tampa 2 puntos
- 2 Cierrapuertas 3005
- Manija Eiffel
- Sello perimetral negro 7.62mt
- 6 Bisagras MAC – PRO 4.5 X 4.5 26D
- One Tampa 1 point exit device
- One Tampa 2 points exit device
- Two 3005 series door closer
- One Eiffel trim
- Perimetral gasketing 7.62mts
- 6 Mac Pro hinge 4.5" x 4.5"



Combo sencillo Orlando 1 punto / 1 point Orlando single combo

- Una barra antipánico Orlando 1 punto
- Un cierrapuertas hidráulico serie 3005
- Una manija exterior Orión
- One Orlando 1 point exit device
- One 3005 series door closer
- One Orión lever

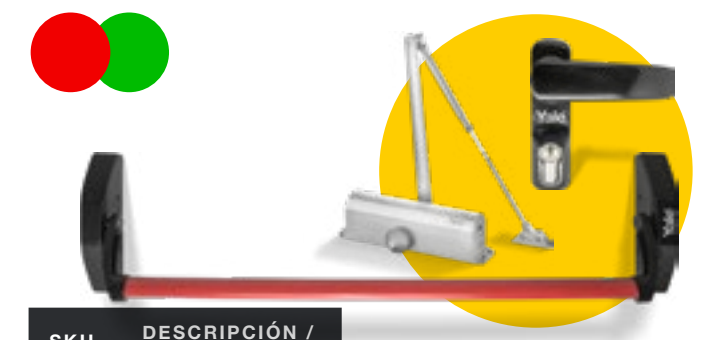

SKU	DESCRIPCIÓN / DESCRIPTION
0034934	Com Senci Antip Orl A 1P
0034935	Com Senci Antip Orl P 1P
0034936	Com Senci Antip Orl R 1P
0034937	Com Senci Antip Orl V 1P

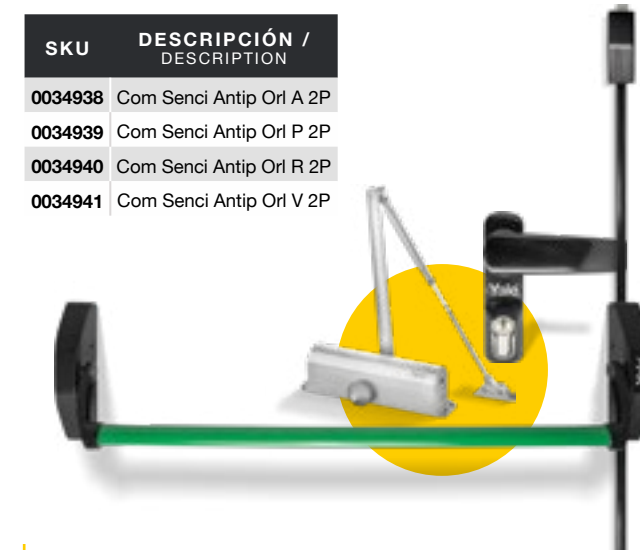

SKU	DESCRIPCIÓN / DESCRIPTION
0034938	Com Senci Antip Orl A 2P
0034939	Com Senci Antip Orl P 2P
0034940	Com Senci Antip Orl R 2P
0034941	Com Senci Antip Orl V 2P

Combo sencillo Orlando 2 puntos / 2 points Orlando single combo

- Una barra antipánico Orlando 2 puntos
- Un cierrapuertas hidráulico serie 3005
- Una manija exterior Orión
- One Orlando 2 points exit device
- One 3005 series door closer
- One Orión lever



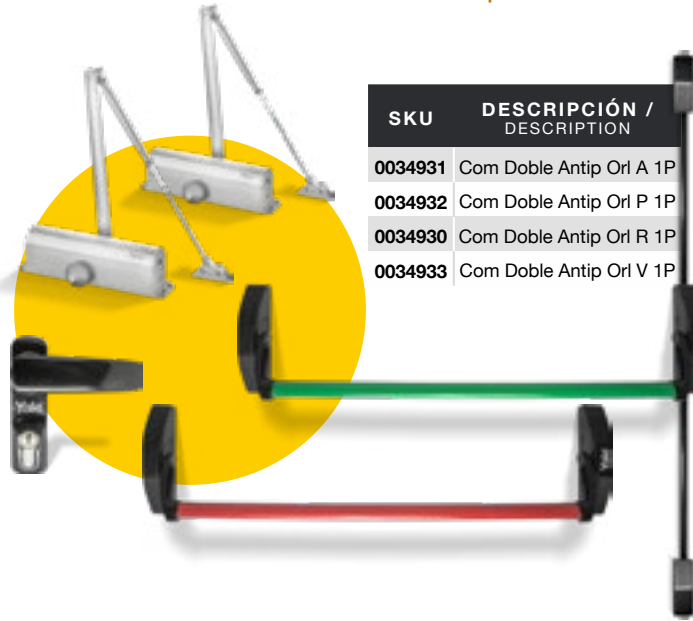

SKU	DESCRIPCIÓN / DESCRIPTION
0034931	Com Doble Antip Orl A 1P
0034932	Com Doble Antip Orl P 1P
0034930	Com Doble Antip Orl R 1P
0034933	Com Doble Antip Orl V 1P

Combo doble Orlando 2 puntos / 2 points Orlando double combo

- Una barra antipánico Orlando 1 punto
- Una barra antipánico Orlando 2 puntos
- Dos cierrapuertas hidráulico serie 3005
- Una manija exterior Orión
- One Orlando 1 point exit device
- One Orlando 2 points exit device
- Two 3005 series door closer
- One Orión lever



MANIJAS Y CERROJOS

Levers and deadbolts

Manijas institucionales / Commercial levers

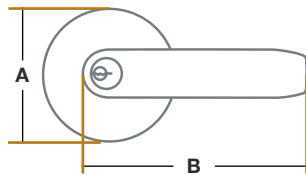

MEDIDAS EN mm. / MEASURES IN mm.

A	B
95	135

SKU	DESCRIPCIÓN / DESCRIPTION
0009044	Manija Inst Baño US26D
0009049	Manija Inst Bodega US26D
0009043	Manija Inst Aula US26D
0009091	Manija Inst Alcoba US26D

- Manija cilíndrica reversible
- ANSI/BHMA A156.2 Grado 2
- 400.000 ciclos
- ANSI A117.x1 Código de acceso (ADA Compliant)
- UL/cUL Listed (3 horas)
- UL10C/UBC 7-2 Presión nominal positiva
- UL10B Presión nominal
- Backset de 70mm - Grosor de puerta: 35 a 45mm
- Placa frontal, cantonera, pestillo y escudo en acero inoxidable
- Manija en aleación de zinc
- Cilindro en latón con 6 pines
- 3 llaves
- Reversible cylindrical lever
- ANSI/BHMA A156.2 Grade 2
- 400,000 cycles
- ANSI A117.1 Access code (ADA Compliant)
- UL/cUL Listed (3 hours)
- UL10C/UBC 7-2 Positive pressure rated
- UL10B Pressure rated
- Backset: 70mm - Door thickness: 35 to 45mm
- Stainless steel faceplate, strike, latch bolt and rose
- Zinc alloy lever
- Brass cylinder with 6 pins
- 3 keys

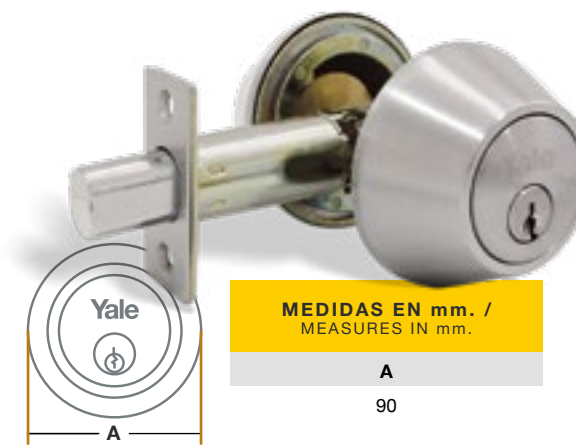

MEDIDAS EN mm. / MEASURES IN mm.

A
90

SKU	DESCRIPCIÓN / DESCRIPTION
0009088	Cerrojo Inst LM US26D
0009045	Cerrojo Inst LI LI US26D

Cerrojos institucionales / Commercial deadbolts

- Backset de 70mm
- ANSI/BHMA A 156.5-2001 Grado 2
- 150.000 ciclos
- UL/ULC listed 3 horas
- Grosor de puerta: 35 a 45mm
- Placa frontal de acero inoxidable
- Cantonera en acero
- Cilindro en latón, 3 llaves y 5 pines
- 70mm backset
- ANSI/BHMA A 156.5-2001 Grade 2
- 150,000 cycles
- UL/ULC listed 3 hours
- Door thickness: 35 to 45mm
- Stainless steel faceplate
- Steel strike
- Brass cylinder, 3 keys and 5 pins



NUESTROS PRODUCTOS INSTITUCIONALES Y LA NORMATIVIDAD UL

Uno de los aspectos a tener en cuenta al momento de clasificar dispositivos de cierre y apertura es identificar qué tipo de certificación posee de acuerdo a los estándares internacionales.

Una de las más importantes y que todo cierrapuertas instalado en una salida de emergencia debe tener, es la certificación **UL (Underwriters Laboratories)**, la cual es una compañía estadounidense especializada en evaluar y certificar productos que

por su naturaleza pueden salvaguardar la integridad humana en situaciones potencialmente riesgosas.

Los dispositivos de la línea institucional cuentan con certificación UL para Fire Exit Hardware, lo que significa que en caso de presentarse un incendio en el área donde se encuentran instalados los productos, estos son capaces de resistir hasta 3 horas, posibilitando la realización de un proceso de evacuación seguro.

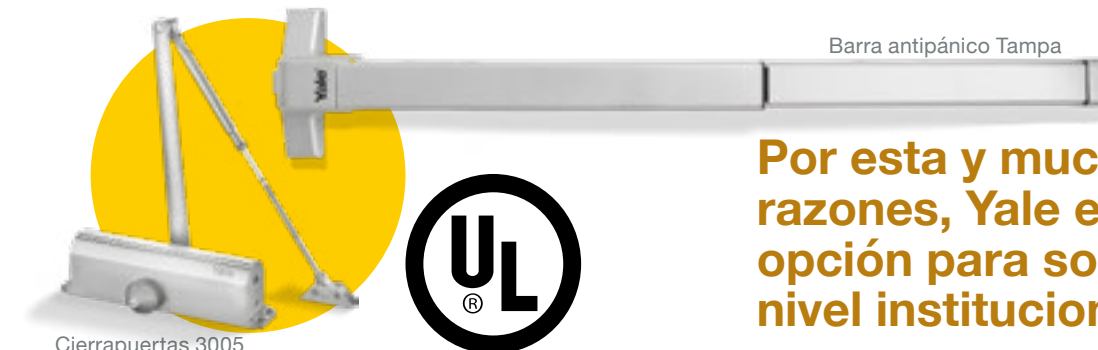

Cierrapuertas 3005

Por esta y muchas otras razones, Yale es la mejor opción para soluciones a nivel institucional.

BISAGRAS

Hinges

Mckinney ref. MPB79



Bisagra Mac Pro 4.5" x 4.5" / Mac Pro hinge 4.5" x 4.5"

- Una bisagra de excelente calidad a un precio económico
- Bisagra de cinco nudillos con dos baleros
- Apta para uso en puertas cortafuego.
- Cumple ANSI/BHMA 156.1, 156.7
- 3 unidades por empaque
- Otras opciones bajo pedido: Dimensión de 4.5" x 4", pins no removable (NRP)
- An excellent quality hinge at an affordable price
- Five knuckle hinge with two bearings
- Can be to use on fire rated doors.
- Meets ANSI / BHMA 156.1, 156.7
- 3 units per package
- Other options on request: Dimension 4.5 "x 4", non-removable pins (NRP)

SKU	DESCRIPCIÓN / DESCRIPTION
0007606	Bisa Mac-Pro 4.5x4.5 US26D

Bisagra Balinera 4.5" x 4.5" / Ball bearing hinge 4.5" x 4.5"

- Bisagra de cinco nudillos con dos baleros
- Apta para uso en puertas cortafuego
- Certificada y contramarcada UL
- Recomendada para uso en puertas de alta frecuencia o puertas con cierrapuertas
- Cumple ANSI/BHMA 156.1, 156.7
- 3 unidades por empaque
- Otros tamaños disponibles bajo pedido
- Múltiples opciones disponibles bajo pedido (NRP, Hospital Tip, Safety Stud Feature, Electrolynx, entre otras)
- Five knuckle hinge with two bearings
- Can be use on fire rated doors
- UL certified and labeled
- Recommended for use in high frequency doors or doors with closers
- Meets ANSI / BHMA 156.1, 156.7
- 3 units per package
- Other sizes available on request
- Multiple options are available on request (NRP, Hospital Tip, Safety Stud Feature, ElectroLynx, etc.)



Mckinney ref. TA2714

SKU	DESCRIPCIÓN / DESCRIPTION
0007506	Bisa Balinera 4.5x4.5 US26D

Bisagra Resortada 4.5" x 4.5" / Spring hinge 4.5" x 4.5"



Mckinney ref. MacPro MPS60

SKU	DESCRIPCIÓN / DESCRIPTION
0007693	Bisa Resortada 4.5x4.5 US26D

- Certificadas UL
- Recomendada en aplicaciones de trabajo estándar donde se requiera control de cierre como en apartamentos, hoteles, edificios de oficinas, etc.
- Son una alternativa para reemplazar el cierrapuertas, sin embargo no ofrecen el mismo nivel de control
- Para puertas cortafuego deben usarse mínimo dos bisagras por puerta
- Cumplen con ANSI/BHMA 156.1, 156.7, 156.17
- 3 unidades por empaque
- No disponible en otros tamaños ni opciones adicionales.
- UL certified
- Recommended for standard weight applications where closing control is required as
- in apartments, hotels, office buildings, etc.
- An alternative to replace closers, but do not offer the same level of control
- Fire doors should be use at least two spring hinges
- Meets ANSI / BHMA 156.1, 156.7, 156.17
- 3 units per package
- Not available in other sizes or additional options.

ACCESORIOS

Accessories

Sello Bajo Puerta 0.91mt / Door bottom 0.91mt

- Fabricado de aleación de aluminio con inserto de vinilo
- Apto para uso en puertas cortafuego, certificado UL
- Viene con tornillos en acero inoxidable
- Se complementa con el uso del pirlan para aperturas que requieran un sello o hermeticidad total
- Made of aluminum alloy with vinyl insert
- Suitable for use in fire doors, UL certified
- With stainless steel screws
- It is complemented by the use of threshold for openings requiring a seal or leakproof seal

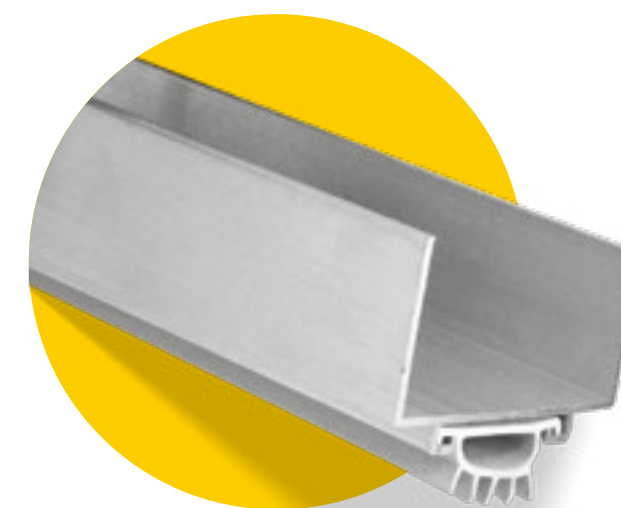

SKU	DESCRIPCIÓN / DESCRIPTION
0007725	Sello Bajo Puerta 0.91MT Alum

Pemko ref. 217AV36"



Pemko ref. S88BL18"

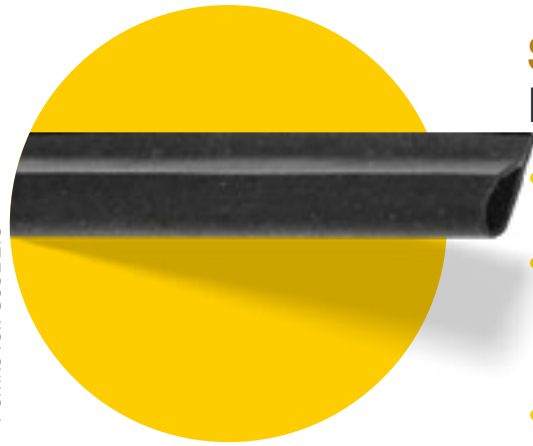

Sello Perimetral Negro / Perimeter gasketing

- Testeado contra humo, según UL1784-01
- Autoextinguible y No toxico. No se afecta por la luz del sol, exposición al ambiente o rayos ultravioleta.
- Cumple los requerimiento de la NFPA105
- Apto para usar en marcos metálicos de aperturas certificadas cortafuego.
- Smoke tested according UL1784-01
- Self-extinguishing and non-toxic. Unaffected by sunlight, environmental exposure or ultraviolet rays.
- Meets the requirement of the NFPA105
- Can be use in metal frames openings certified firewall.

SKU	DESCRIPCIÓN / DESCRIPTION
0007635	Sello Perimetral Negro 5.40mt
0007728	Sello Perimetral Negro 7.62mt

Falleba 555 US26D / Flushbolt 555 US26D

- Fabricado en Latón
- Para puertas dobles hasta de 8' (2.44mt) de ancho x 10' (3.00mt) de alto.
- Su función principal es asegurar la hoja inactiva en una apertura doble.
- Si la apertura es una salida de emergencia no se deben instalar fallebas, o en su defecto estas deberán ser del tipo automático.
- Dos unidades en empaque
- Made of brass
- For double doors to 8 '(2.44mt) wide x 10' (3.00mt) high.
- Its main function is to lock the inactive leaf in a double opening.
- If the opening is an emergency exit flushbolt should not be installed , or otherwise they must be of the automatic type.
- Two units per package



Rockwood ref. 555.26D

SKU	DESCRIPCIÓN / DESCRIPTION
0007648	Falleba 555 US26D

Pemko ref. 270A36"



Pirlan / Treshold

- Fabricado de aleación de aluminio
- Apto para uso en puertas cortafuego, certificado UL.
- Se complementa con el uso del sello bajo puerta para aperturas que requieran un sello o hermeticidad total.
- Manufactured aluminum alloy frame
- Can be use in fire doors, UL certified
- It is complemented by the use of the door bottom on door openings requiring a seal or leakproof seal.

SKU	DESCRIPCIÓN / DESCRIPTION
0007726	Pirlan Pta Senci 0.9mt
0007727	Pirlan Pta Doble 1.98mt



Coordinador Universal / Universal Coordinator

SKU	DESCRIPCIÓN / DESCRIPTION
0007729	Coordinador Universal

Rockwood ref. 1700



- Fabricado en acero
- Para puertas dobles hasta de 8' de ancho (2.44mt)
- Su función principal es garantizar que la puerta activa cierre correctamente sobre la puerta inactiva.
- Made of steel
- For double doors up to 8 'wide (2.44mt)
- Its main function is to ensure that the active door closes properly over the inactive door.

KITS PUERTA CORTAFUEGO

Fire rated door kits

Disponibles para puerta sencilla y doble / Available for single and double doors

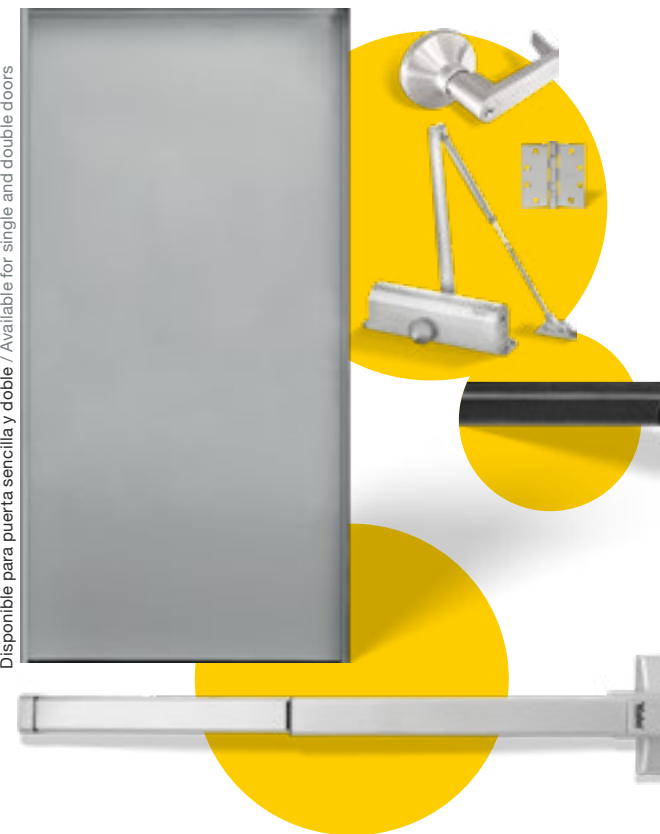

Kit puerta cortafuego Tampa / Fire rated Tampa door kit

- Puerta metálica galvanizada de 45mm
- Marco de puerta
- Bisagra MPB79
- Barra antipánico Tampa
- Manija exterior Eiffel
- Cierrapuertas 3005
- Sello perimetral
- 45mm galvanized metal door
- Door frame
- MPB79 hinge
- Tampa exit device
- Eiffel Trim
- 3005 series door closer
- Perimetral gasketing



SKU	DESCRIPCIÓN / DESCRIPTION
0034903	Kit P Corta Fuego I RE
0034904	Kit P Corta Fuego D RE

Disponible para puerta sencilla y doble / Available for single and double doors



Kit puerta cortafuego Tampa 2234 / 2234 fire rated Tampa door kit

- Puerta metálica galvanizada de 45mm
- Marco de puerta
- Bisagra MPB79
- Barra antipánico Tampa
- Manija exterior Eiffel
- Cierrapuertas 2234
- Sello perimetral
- 45mm galvanized metal door
- Door frame
- MPB79 hinge
- Tampa exit device
- Eiffel Trim
- 2234 series door closer
- Perimetral gasketing



SKU	DESCRIPCIÓN / DESCRIPTION
0034903	Kit P Corta Fuego I RE
0034904	Kit P Corta Fuego D RE

Kit puerta cortafuego Orlando / Fire rated Orlando door kit

- Puerta metálica galvanizada de 45mm
- Marco de puerta
- Bisagra MPB79
- Barra antipánico Orlando
- Manija exterior Orión
- Cierrapuertas 2234
- Sello perimetral
- 45mm galvanized metal door
- Door frame
- MPB79 hinge
- Orlando exit device
- Orión Trim
- 2234 series door closer
- Perimetral gasketing



SKU	DESCRIPCIÓN / DESCRIPTION	SKU	DESCRIPCIÓN / DESCRIPTION
0034912	Kit Puerta D 2234 Orl A	0034921	Kit Puerta I 2234 Orl A
0034914	Kit Puerta D 2234 Orl P	0034922	Kit Puerta I 2234 Orl P
0034915	Kit Puerta D 2234 Orl R	0034923	Kit Puerta I 2234 Orl R
0034916	Kit Puerta D 2234 Orl V	0034924	Kit Puerta I 2234 Orl V

Disponible para puerta sencilla y doble / Available for single and double doors



Disponible para puerta sencilla y doble / Available for single and double doors



Kit puerta cortafuego Orlando resortada / Fire rated Orlando door kit

- Puerta metálica galvanizada de 45mm
- Marco de puerta
- Bisagra resortada MPS60
- Barra antipánico Orlando
- Manija exterior Orión
- Sello perimetral
- 45mm galvanized metal door
- Door frame
- MPS60 spring hinge
- Orlando exit device
- Orión Trim
- Perimetral gasketing



SKU	DESCRIPCIÓN / DESCRIPTION	SKU	DESCRIPCIÓN / DESCRIPTION
0034917	Kit Puerta D Bisag Orl A	0034926	Kit Puerta I Bisag Orl A
0034918	Kit Puerta D Bisag Orl P	0034927	Kit Puerta I Bisag Orl P
0034919	Kit Puerta D Bisag Orl R	0034928	Kit Puerta I Bisag Orl R
0034920	Kit Puerta D Bisag Orl V	0034929	Kit Puerta I Bisag Orl V

POR QUÉ ESCOGER NUESTROS PRODUCTOS

LAS PUERTAS CORTAFUEGO SIRVEN PARA SALVAR VIDAS.

- El responsable de dar cumplimiento con la **NSR 10** – Capítulos J y K en requisitos contra el fuego es el constructor (J.1.1.3 de la **NSR-10**).
- Toda edificación debe poseer salidas adecuadas para una fácil, rápida y segura evacuación (K.3.2.1 de la **NSR-10**).
- Existen unas medidas mínimas de ancho y altura libre de las puertas en la norma para usos individuales según el numeral K.3.3.3 de la **NSR-10**.

- En una puerta certificada todos sus componentes cuentan con un aval físico de un laboratorio reconocido y por lo tanto le debe ser entregado para sus registros y ser visible en la puerta, marco y dispositivos (**UL, WH, FM y BSI**).
- Las puertas certificadas tienen un máximo de 1,21 x 3,04 para **hoja sencilla** y 2,43 x 3,04 para **hojas dobles**.
- Existen puertas certificadas a **diferentes minutos** (20, 45, 60, 90 y 180).
- *Los dispositivos de cierre y salida para salidas de evacuación no son los mismos que para puertas cortafuego.*



Fire Exit certified



Panic certified

No olvide buscar estas certificaciones en nuestros productos

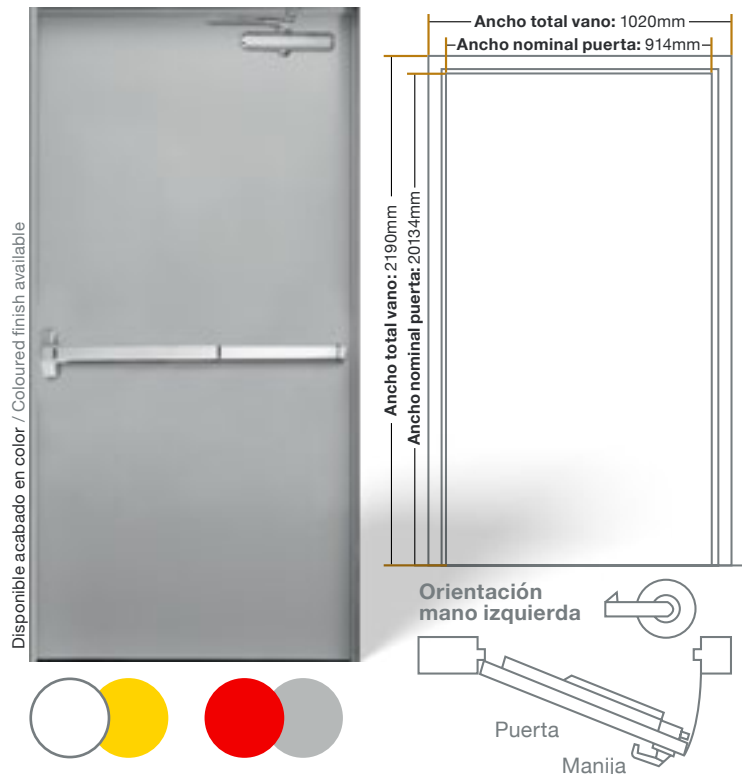

Puerta cortafuego



Puerta

Puerta metálica galvanizada de 45mm de espesor con diseño liso, resistente al fuego (90 minutos) con certificación UL, abatible hacia ambos lados, calibre 20. Medida: 914mm x 2134mm

- Interior Honeycomb
- Uniones por "Interlocked"
- Canales invertidos "Top/Btm"
- Refuerzo de bisagra calibre 7
- Acabado "Prime" anti corrosión
- Preparaciones estándar
- 250.000 ciclos de uso en calibre 20
- Nivel 1 comercial ligero

Marco

Compuesto por:

- Paral de bisagras galvanizado, calibre 16
- con preparación para 3 bisagras de 4.5" x 4.5"
- Paral de cantonera galvanizado, calibre 16 con refuerzo interno para cantonera de barra antipánico
- Cabezal galvanizado, calibre 16
- Para puertas de 1-3/4" (45mm) de espesor
- Calibre 16 (1.3mm)
- Uniones Knocked Down
- Refuerzo de bisagra calibre 7
- Acabado "Prime" anti corrosión
- Preparaciones estándar
- 1,000,000 ciclos de uso en calibre 16

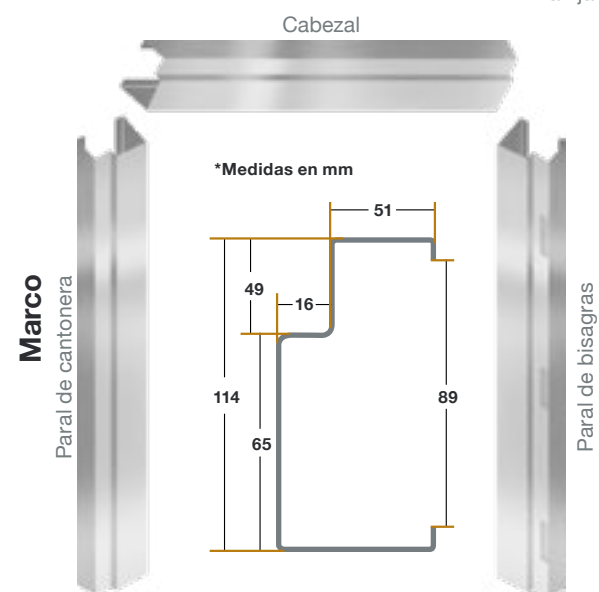

- Disponibles en stock para vanos de: 1.02 x 2.19m - 1.20 x 2.19m **Otras medidas bajo pedido**

SKU	DESCRIPCIÓN / DESCRIPTION
0003502	Pintura Amarilla
0003500	Pintura Roja
0003504	Pintura Blanca
0003506	Pintura Gris

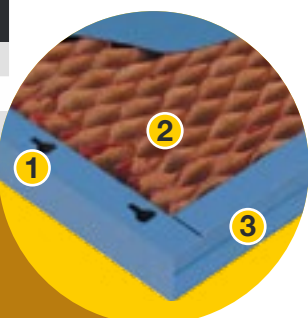

Construcción de la puerta

1. Grafados mecánicamente y dobladillo de costura en borde vertical para mayor resistencia y rigidez.
2. Su núcleo en Honeycomb le provee fuerza estructural y la hace extremadamente liviana.
3. Canales invertidas (superior e inferior) soldadas a las láminas de ambas caras



DIGITAL
Digital

Yale introduce al mercado lo último en tecnología para la seguridad de los hogares, oficinas y comercio. Los productos van desde cerraduras digitales que sorprenden a los usuarios con innovadores métodos de apertura hasta cajas fuertes con códigos que brindan la más alta seguridad a los objetos de valor, eso sin mencionar las mirillas digitales que harán que todos vean a través de su puerta de una nueva forma.

Yale introduces to the market the latest technology in security for home, offices and light commercial applications. The products go from digital locks with touch-screen technology to safes with codes that bring the highest security to the valuables and personal belongings. The digital door viewers line will enable everyone to see through their doors in a whole new way.

GLOSARIO

Glossary

Características / Features:

Usa tarjetas Uses cards	Programación asistida por voz Voice assisted programming	Resiste intemperie Weather resistant	Instalación sencilla Easy installation	Cierre automático Auto relock	No más llaves No more keys	Alarma de batería baja y vandalismo Low battery and tamper alert	Usa 2 baterías AAA Uses 2 AAA batteries
Diámetro Diameter	Ángulo de visión Viewing angle	Usa memoria SD Uses SD card	Timbre Door bell	Usa 4 baterías AA Uses 4 AA batteries	Grosor de la puerta Door thickness	Tamaño de pantalla Screen size	Registra hora y fecha Records date and time
Apertura biométrica Biometric opening	No requiere perforación No drilling required	Opción memoria incluida Memory included option	4 bullet - 4 domo 4 bullet - 4 dome	4 cámaras domo 4 dome cameras	4 cámaras bullet 4 bullet cameras	Visión nocturna Night vision	Cámaras de 1 MP 1 MP cameras
1 TB disco duro 1 TB hard drive	Fácil instalación DIY installation	En partes mecánicas On mechanical parts	Tres llaves Three keys	Para fácil apertura a distancia For easy remote opening	Compatible con Yale connect Yale connect compatible	Conformidad Europea European Conformity	Comisión Federal de Comunicación Federal Communications Commission
Bluetooth	Opción módulo Z-Wave Z-Wave module option	Opción módulo ZigBee ZigBee module option	Instituto Nacional Estadounidense de Estándares American National Standards Institute				

Abreviatura / Abbreviation:

YRL: Yale Real Living
Digi: Digital / Digital
Sobre: Sobreponer / Rim lock
Zbee: Zigbee

7": 7 pulgadas / 7 inches
VCD/ VDC: Voltaje corriente directa / Voltage direct current

Acabados / Finishes:

US15 Niquel satinado / Satin nickel	US10B Negro / Black	Azul / Blue
--	----------------------------------	-------------



Yale connect HUB / Yale Connect HUB

- Alimentación: 5VDC, 1A.
 - Requerimientos del sistema: Yale Connect App, IOS 7+, Android OS 4.0+, router WiFi con conexión a internet de banda ancha para la configuración inicial y para controlar los dispositivos de manera remota.
 - Conexión HUB y router vía WiFi 802.11 b/g/n.
 - Alcance máximo entre HUB y dispositivos Yale Connect: 30 mts. en áreas abiertas.
 - Conexión segura (SLL) entre App y Nube.
 - Sólo para uso en interiores.
- Power requirement: 5VDC, 1A.
 - System requirements: Yale Connect App, IOS 7+, Android OS 4.0+, broadband internetconnected wireless router for initial set up and to remotely control devices.
 - HUB to Router connection via WiFi 802.11 b/g/n.
 - Max single Yale Connect component range: 30 mts. open field.
 - Secure SSL WiFi connections from App to Cloud.
 - For interior use only.

MEDIDAS EN mm. / MEASURES IN mm.	
A	B
92	100

SKU	DESCRIPCIÓN / DESCRIPTION
0006636	Yale Connect HUB



CERRADURAS DIGITALES

Digital door locks

Cerrojo YDD114 / YDD114 deadbolt

- 10 códigos de usuario
- Teclado iluminado
- Alarma de batería baja
- Cierre automático
- Grosor puerta: 30 a 45mm
- Backset ajustable: 60 a 70mm
- Acabado en niquel satinado
- Usa 4 baterías AA
- 10 user codes
- Backlit keyboard
- Low battery alert
- Auto blocking
- Weather resistant
- Door Thickness: 30 to 45mm
- Adjustable backset: 60 to 70mm
- Sanit nickel finish
- Uses 4 AA batteries



MEDIDAS EN mm. / MEASURES IN mm.	
A	B
140	62

SKU	DESCRIPCIÓN / DESCRIPTION
0009096	Yale Digi Cerrojo 114

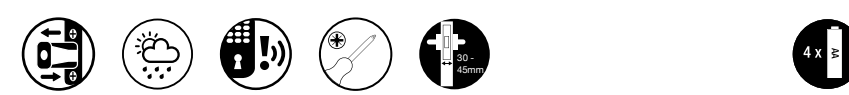

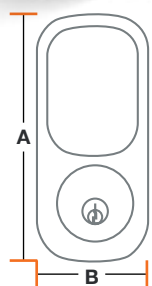

MEDIDAS EN mm. / MEASURES IN mm.	
A	B
150	65

SKU	DESCRIPCIÓN / DESCRIPTION
0009022	YRL Cerrojo Digital
0009114	YRL Cerrojo Digital Negro



YRL Cerrojo digital / YRL touchscreen deadbolt

- Códigos (únicos) para (hasta) 25 usuarios (opción de 250 con los módulos ZigBee o Z-wave)
 - Resistente a la intemperie
 - Cierre automático
 - Indicador de batería baja y vandalismo
 - Construcción metálica
 - 4 baterías AA (incluidas)
 - Grosor puerta: 35 a 57mm
 - Backset ajustable: 60 a 70mm
 - Certificado ANSI/BHMA A156.36, grado 2
- (Unique) Codes for (up to) 25 users (250 option with Zigbee or Z-wave modules)
 - Weather resistant
 - Auto relock
 - Low battery and tamper alert
 - Metal construction
 - 4 AA batteries (included)
 - Door thickness: 35 to 57mm
 - Adjustable backset: 60 to 70mm
 - ANSI/BHMA A156.36, grade 2 Certified



YRD246 / YRD246

- Capacidad para 30 códigos de usuario
 - Pantalla táctil
 - Menú guiado por voz
 - Bloqueo automático con opción de cierre manual
 - Alarma por intrusión o daño
 - Alarma de batería baja
 - Fácil registro de credenciales
 - Puerto de batería de emergencia
 - Grosor puerta: 35 a 57mm
 - Backset ajustable: 60 a 70mm
- Up to 30 user codes
 - Touch screen
 - Voice guided menu
 - Automatic locking, manual lock option available
 - Break-in and damage alarm
 - Low battery alarm
 - Easy credential registration
 - Emergency power
 - Door thickness: 35 to 57mm
 - Adjustable backset: 60 to 70mm

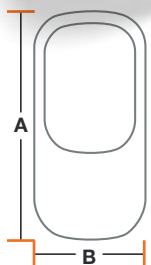

MEDIDAS EN mm. / MEASURES IN mm.	
A	B
140	65

SKU	DESCRIPCIÓN / DESCRIPTION
0009136	YRL Cerrojo No Llave



MEDIDAS EN mm. / MEASURES IN mm.	
A	B
90	63

SKU	DESCRIPCIÓN / DESCRIPTION
0009146	YRL Cerrojo Assure SL

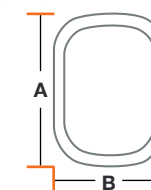

YRD256 / YRD256

- Códigos (únicos) para (hasta) 25 usuarios (opción de 250 con los módulos ZigBee o Z-wave)
 - Resistente a la intemperie
 - Cierre automático
 - Indicador de batería baja y vandalismo
 - Construcción metálica
 - 4 baterías AA (incluidas)
 - Grosor puerta: 35 a 57mm
 - Backset ajustable: 60 a 70mm
 - Certificado ANSI/BHMA A156.36, grado 2
- (Unique) Codes for (up to) 25 users (250 option with Zigbee or Z-wave modules)
 - Weather resistant
 - Auto relock
 - Low battery and tamper alert
 - Metal construction
 - 4 AA batteries (included)
 - Door thickness: 35 to 57mm
 - Adjustable backset: 60 to 70mm
 - ANSI/BHMA A156.36, grade 2 Certified



YDF40 / YDF40

- Hasta 20 huellas dactilares
 - Capacidad para 30 códigos de usuario
 - Pantalla táctil
 - Menú guiado por voz
 - Bloqueo automático con opción de cierre manual
 - Alarma por intrusión o daño
 - Alarma de batería baja
 - Puerto auxiliar de batería: 9V
 - Grosor puerta: 30 a 57mm
 - Backset ajustable: 60 a 70mm
- Up to 20 finger prints
 - Up to 30 user codes
 - Touch screen
 - Voice guided menu
 - Automatic locking, manual lock option available
 - Break-in and damage alarm
 - Low battery alarm
 - 9V Emergency power terminal port
 - Door thickness: 30 to 57mm
 - Adjustable backset: 60 to 70mm

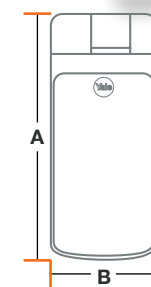
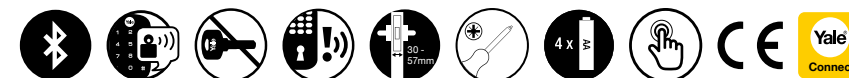

MEDIDAS EN mm. / MEASURES IN mm.	
A	B
176	66

SKU	DESCRIPCIÓN / DESCRIPTION
0010868	Yale Digi Cerrojo YDF40
0007063	Módulo Bluetooth
0011295	Módulo remoto N Protocol
0009084	Control Remoto

YRL Manija digital / YRL Lever touchscreen

MEDIDAS EN mm. /
MEASURES IN mm.

A	B	C
150	65	152

SKU DESCRIPCIÓN /
DESCRIPTION

0009032	YRL Manija Digital
---------	--------------------

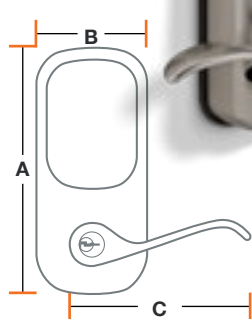

- Códigos (únicos) para (hasta) 25 usuarios (opción de 250 con módulos ZigBee o Z-wave)
- Unique Codes for (up to) 25 users (250 option with Zigbee or Z-wave modules)
- Manija reversible para puertas izquierdas y derechas
- Reversible levers for left and right handed doors
- Resistente a la intemperie
- Weather resistant
- Bloqueo automático
- Auto blocking
- Indicador de batería baja y vandalismo
- Low battery and tamper alert
- Construcción metálica
- Metal construction
- 4 baterías AA (incluidas)
- 4 AA batteries (included)
- Grosor puerta: 35 a 45mm
- Door thickness: 35 to 45mm
- Backset ajustable: 60 a 70mm
- Adjustable backset: 60 to 70mm
- Certificado ANSI/BHMA A156.36, grado 2
- ANSI/BHMA A156.36, grade 2 Certified



YDM3212 / YDM3212

- Teclado táctil
- Touch screen
- Capacidad para 20 tarjetas (4 incluidas)
- Up to 20 proximity cards (4 included)
- 1 código de usuario de 4 a 10 dígitos
- 1 user code, 4 to 10 digits
- Alarma de fuego, intrusión y daño
- Fire, trespassing and tamper alarm
- Resistente a choques eléctricos
- Electric shock resistant
- Caja con cerrojo y pestillo resbalón
- Box with bolt and latch
- Puerto auxiliar de batería: 9V
- 9V Emergency power terminal port
- Control remoto (opcional)
- Remote control (optional)
- Grosor puerta: 40 a 55mm
- Door thickness: 40 to 55mm
- Backset de 70mm
- Backset: 70mm

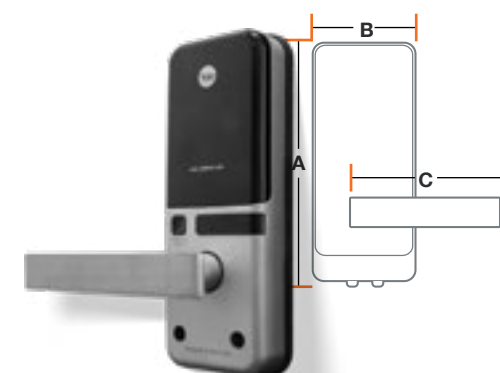

MEDIDAS EN mm. /
MEASURES IN mm.

A	B	C
200	74	140

SKU DESCRIPCIÓN /
DESCRIPTION

0007063	Módulo Bluetooth
0009095	Yale Digi embutir 3212
0008934	Módulo Remoto RX
0009084	Control Remoto

YMF30 / YMF30

MEDIDAS EN mm. /
MEASURES IN mm.

A	B	C	D	E
68	320	112	153	23

SKU DESCRIPCIÓN /
DESCRIPTION

0010952	Yale Digi embutir YMF30
0007063	Módulo Bluetooth
0011293	Módulo remoto N Protocolo
0009084	Control Remoto

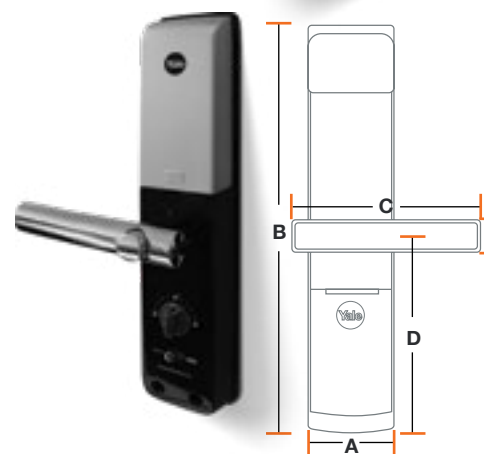

- Hasta 40 tarjetas de proximidad (4 incluidas)
- Up to 40 proximity cards (4 included)
- 30 claves de usuario (4 a 10 dígitos)
- 30 user pins code (4 to 10 digits)
- Pantalla táctil
- Touch screen
- Bloqueo automático
- Auto relock
- Alarma de intrusión, daño
- Alarm (break in /damage)
- Indicador de batería
- Low battery indicator
- Puerto auxiliar de batería 9V
- 9V emergency power terminal port
- Control remoto (opcional)
- Remote control (optional)
- Manija de emergencia
- Anti panic egress lever
- Grosor puerta: 35 a 100mm
- Door thickness: 35 to 100mm
- Backset: 60mm
- Backset: 60mm



YMF40 / YMF40

- Hasta 20 huellas dactilares
- Up to 20 finger prints
- Capacidad para 30 códigos de usuario
- Up to 30 user codes
- Pantalla táctil
- Touch screen
- Menú guiado por voz
- Voice guided menu
- Bloqueo automático con opción de cierre manual
- Automatic locking, manual lock option available
- Alarma por intrusión o daño
- Break-in and damage alarm
- Alarma de batería baja
- Low battery alarm
- Manija de emergencia
- Anti panic egress lever
- Grosor puerta: 35 a 100mm
- Door thickness: 35 to 100mm
- Backset: 60mm
- Backset: 60mm

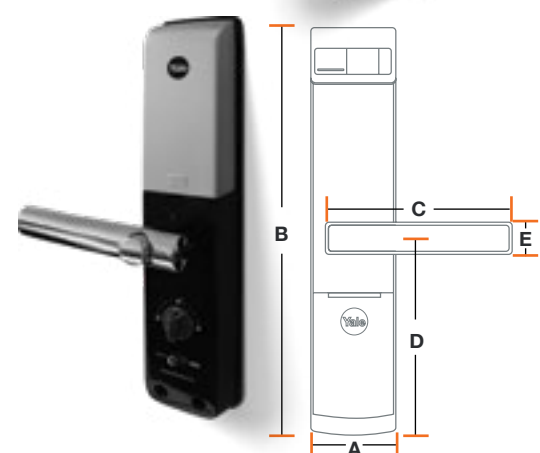

MEDIDAS EN mm. /
MEASURES IN mm.

A	B	C	D	E
68	320	112	153	23

SKU DESCRIPCIÓN /
DESCRIPTION

00010953	Yale Digi embutir YMF40
0007063	Módulo Bluetooth
0011293	Módulo remoto N Protocolo
0009084	Control Remoto

PARA PUERTAS DE VIDRIO

For glass doors

MEDIDAS EN mm. / MEASURES IN mm.	
A	B
185	72

SKU	DESCRIPCIÓN / DESCRIPTION
0008897	Yale Digi Vidrio 313
0007063	Módulo Bluetooth
0008934	Módulo Remoto RX
0009084	Control Remoto

YDG313 / YDG313

- No requiere perforaciones
- Para puertas de vidrio
- Hasta 40 tarjetas de proximidad (4 incluidas)
- Alarma de alta temperatura, batería baja y contra vandalismo
- Pantalla táctil inteligente (con tecnología de espejo)
- Acceso por código falso o escondido
- Bloqueo automático
- Resistente a descargas eléctricas
- Puerto auxiliar de batería: 9V
- 4 baterías AA (incluidas)
- Grosor puerta: 10 a 12mm
- No additional holes required
- For glass doors
- High temperature (fire), low battery and tamper alarm
- Smart touch screen (with mirror technology)
- Easy card registration
- 4 proximity cards (up to 40 cards)
- False or hidden code access
- Automatic locking
- Electric shock resistant
- 9V emergency power terminal port
- 4 AA batteries (included)
- Door thickness: 10 to 12mm

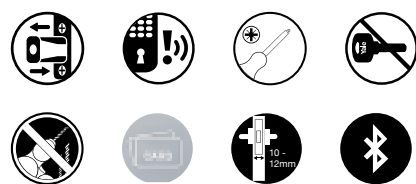

Controle **su cerradura** desde cualquier lugar del mundo

HUB + CERRADURA DIGITAL

HUB + Digital door lock

Yale HUB cambia la forma en la que usa su cerradura / Yale HUB changes the way you use your door lock

Yale Connect HUB cambia las reglas de juego cuando se trata de accesibilidad a sus cerraduras digitales Yale.

Gracias a su interacción con la aplicación, *disponible para Android y iOS*, usted podrá abrir, cerrar, asignar códigos y crear horarios de apertura de sus cerraduras digitales, cerraduras eléctricas y electroimanes **desde cualquier parte del mundo.**

Mediante Yale Connect Hub y la aplicación Yale Connect puedes abrir y cerrar dispositivos Yale como cerraduras digitales, cerraduras eléctricas y electroimanes de forma remota y segura desde cualquier parte del mundo con tu smartphone, tablet o PC.

- Descarga y uso de la aplicación totalmente gratis.
- Comparte el control de los dispositivos a diferentes usuarios.
- Asigna códigos de usuario en las cerraduras digitales
- Controla el uso de sus dispositivos mediante reportes de apertura.

Yale Connect HUB changes the game rules when talking about accessibility for your Yale digital locks.

Thanks to its interaction with the app, *available for Android and iOS*, you will be able to open, close, assign codes and create opening schedules for your digital locks, EM rimlocks and maglocks **from anywhere in the world.**

Through Yale Connect HUB and the Yale connect app you can open and close devices from anywhere in the world with your smartphone, tablet or PC.

- Downloading and using the app is completely free.
- Share the devices control to different users.
- Assign user codes to the Digital locks.
- Control the use of your devices through opening reports.

Usted podrá abrir, cerrar, asignar códigos y crear horarios de apertura / You will be able to open, close, assign codes and create opening schedules





YRL Manija digital + Yale HUB /
YRL Lever touchscreen + Yale HUB

SKU	DESCRIPCIÓN / DESCRIPTION
0011414	Kit Yale Connect+Yrl Man

YRL Cerrojo digital + Yale HUB /
YRL touchscreen deadbolt + Yale HUB



SKU	DESCRIPCIÓN / DESCRIPTION
0011413	Kit Yale Connect+Yrl Cer

YDF40 + Yale Connect HUB /
YDF40 + Yale Connect HUB

SKU	DESCRIPCIÓN / DESCRIPTION
0011415	Kit Yale Connect + Ydf 40



**APERTURA REMOTA -
CREACIÓN DE CÓDIGOS DESDE
UN DISPOSITIVO MOVIL /**

REMOTE OPENING - CODE CREATION
FROM A MOBILE DEVICE



YMF30 + Yale Connect HUB /
YMF30 + Yale Connect HUB

SKU	DESCRIPCIÓN / DESCRIPTION
0011416	Kit yale connect + YMF30

YMF40 + Yale Connect HUB /
YMF40 + Yale Connect HUB

SKU	DESCRIPCIÓN / DESCRIPTION
0011417	Kit yale connect + YMF40



MÓDULOS DE INTEGRACIÓN

Integration modules

Módulos Zigbee / Zigbee modules

- Módulo de R para integración con sistemas de protocolo ZigBee (IEEE 802.15.4)
- Aumenta capacidad de usuarios a 250
- Permite administrar la cerradura remotamente
- Permite bloquear y desbloquear la cerradura desde el celular
- Compatible con sistemas: CRESTRON
- Net module to integrate with Zigbee (IEEE 802.15.4) system protocol
- Increases the users capacity to 250
- Allows to manage the lock remotely
- Allows to block and unlock the lock from the cell phone
- CRESTRON systems compatible



MEDIDAS EN mm. / MEASURES IN mm.

A	B
26	55

SKU	DESCRIPCIÓN / DESCRIPTION
0007038	Módulo Zbee Crestron
0010876	Módulo Zbee C4
00010742	Módulo Zbee YRL
00010743	Módulo Zbee YMF YDF Yale

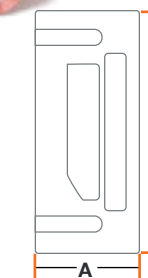

Módulos Zwave / Zwave modules



MEDIDAS EN mm. / MEASURES IN mm.

A	B
26	55

SKU	DESCRIPCIÓN / DESCRIPTION
0010606	Zwave Radio Card

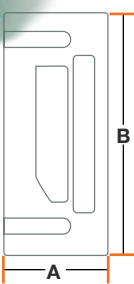

- Módulo de R para integración de Yale Real Living con sistemas de protocolo ZWAVE
- Aumenta capacidad de usuarios a 250
- Permite administrar la cerradura remotamente
- Permite bloquear y desbloquear la cerradura desde el celular
- Compatible con sistemas: Alarm, Leviton, Vera, Honeywell, más

- Net module to integrate the Yale Real Living with ZWAVE protocol systems
- Increases the users capacity to 250
- Allows to manage the lock remotely
- Allows to block and unlock the lock from the cell phone
- Alarm, Leviton, Mi Casa V, Vera, Honeywell and more systems compatible



Módulos Bluetooth / Bluetooth modules

- Módulo para integración de YDM3109, YDM4109, YDM3212, YDG313, YMF30, YMF40 and YDF40 con dispositivos móviles
- Permite bloquear y desbloquear la cerradura desde el celular
- Soporta hasta 8 usuarios (dispositivos móviles)
- Compatible con Android y iOS

- Module to integrate YDM3109, YDM4109, YDM3212, YDG313, YMF30, YMF40 and YDF40 with mobile devices
- Allows to block and unlock the lock from the cell phone
- Support up to 8 users (mobile devices)
- Compatible with Android and iOS



MEDIDAS EN mm. / MEASURES IN mm.

A	B
26	55

SKU	DESCRIPCIÓN / DESCRIPTION
0007063	Módulo Bluetooth

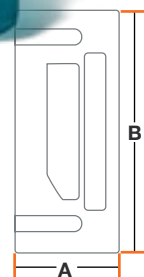

Tarjetas MiFare / MiFare cards



SKU	DESCRIPCIÓN / DESCRIPTION
0007141	Tarjeta MiFare 1k

- Tarjeta inteligente sin contacto
- Frecuencia: 13.56Mhz
- Distancia de lectura: 10cm
- Tarjeta blanca para impresión directa por las 2 caras
- Permite perforación vertical y horizontal para portar como carné
- Compatible con cerraduras: YMF30, YDM3109, YDM3212 y YDG313
- Contactless smart card
- Frequency: 13.56Mhz
- Read distance: 10cm
- Blank card for direct printing of both faces
- Vertical and horizontal perforation allowed
- Direct programming from deadlock
- Compatible with YMF 30, YDM 3109, YDM 3212 y YDG 313

MIRILLAS DIGITALES

Digital door viewer



Yale Real View

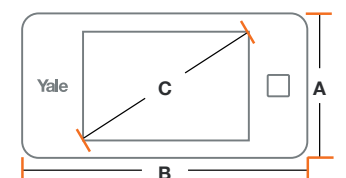

MEDIDAS EN mm. / MEASURES IN mm.

A	B	C
67	125	80 (3,2")

SKU	DESCRIPCIÓN / DESCRIPTION
0009026	Mirilla Digital



- Reemplaza ojo mágico tradicional
- No necesita agujeros adicionales
- Conveniente para niños y personas mayores
- Aumenta la seguridad de su hogar
- Para puertas de 32 a 90mm de espesor
- Mirilla para orificios de 14 a 22mm
- Baterías AAA incluidas (x2)
- Duración baterías: 600 usos
- Replaces traditional door viewer
- No additional holes are necessary
- Convenient for children and elderly people
- Increases home security
- For doors 32 to 90mm thick
- Barrel hole 14 to 22mm
- 2 AAA batteries included
- Battery duration: 600 uses

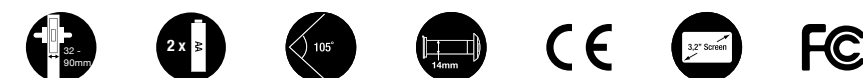

Yale Real View Pro

- No necesita agujeros adicionales, reemplaza ojo mágico tradicional
- Almacena imagen cuando el timbre es activado
- Cámara infraroja: toma imágenes en condiciones de baja luminosidad
- Estampa fecha y hora en imagen
- Graba videos (en forma manual)
- Para puertas 32 a 90mm de espesor
- Mirilla para orificios de 14 a 26mm
- Baterías AA incluidas (x4)
- Duración baterías: 2000 usos sin grabación
- Almacena fotos en memoria (Micro SD de 512MB Incluida)

- No additional holes - replaces traditional door viewer
- Stores image when door bell is activated
- Infrared camera: captures images in low light conditions
- Hour and date stamp on images
- Records video (only manually)
- Door thickness: 32 to 90mm
- Barrel hole 14 to 26mm
- 4 AA batteries included
- Battery duration: 2000 uses without recording
- Stores pictures in memory (512MB Micro SD Card Included)

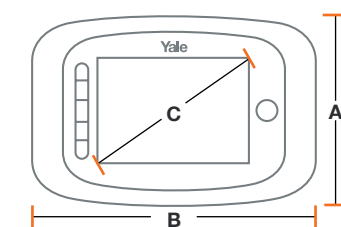

MEDIDAS EN mm. / MEASURES IN mm.

A	B	C
85	135	87 (3,5")

SKU	DESCRIPCIÓN / DESCRIPTION
0009027	Mirilla Digital Pro

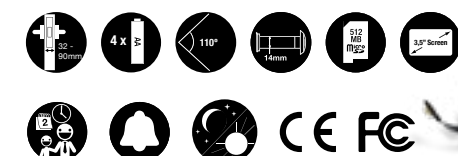

VIDEO PORTERO DIGITAL

Digital video intercom

YDV-7702 / YDV-7702



MEDIDAS EN mm. / MEASURES IN mm.

A	B	C	D	E
139	212	178 (7")	179	90

SKU	DESCRIPCIÓN / DESCRIPTION
0010929	Monitor Video Port Tac7p
0010930	Video Portero Dig Tac 7p

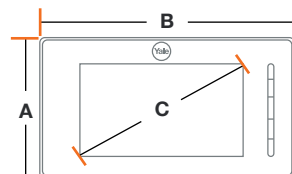

- Registro llamadas perdidas
 - Graba video cuando se activa el frente de calle
 - Pantalla táctil de 7" LCD color
 - Resolución de pantalla: 800 x 3 (RGB) x 480 pixeles
 - Fuente de alimentación de 24V
 - Conexiones: 2 líneas sin polaridad
 - Dimensión: 144(AI) x 244(An) x 23(P)mm
 - Incluye: Monitor, transformador, unidad externa y cable de 10m
 - Intercomunicación con hasta 4 monitores
- Call log
 - Records video when the outdoor station is activated
 - 7" color LCD touch screen monitor
 - Display resolution: 800 x 3 (RGB) x 480 pixels
 - 24V power supply
 - Connection: 2 wires without polarity
 - Dimension: 144(H) x 244(W) x 23(D)mm
 - Includes: Display, transformer, outdoor station and 10m cable
 - Intercommunication with up to 4 monitors



VIDEO PORTERO + CERRADURA ELÉCTRICA

Video intercom + EM Rimlock

Videoportero + cerradura eléctrica / Video intercom + EM Rimlock

SKU	DESCRIPCIÓN / DESCRIPTION
0011460	Kit vipor cerr ele D
0011461	Kit vipor cerr ele I



Características Cerradura eléctrica

- Voltaje de operación: 12V
- Para puertas de metal o madera
- Backset de 60mm
- Apertura eléctrica a distancia
- Tres llaves

EM Rimlock features

- Voltage operation: 12V
- For wood or metal doors
- Backset: 60mm
- Electric opening from a remote position
- Three keys

Características videoportero

- Pantalla táctil de 7" LCD color
- Registro llamadas perdidas
- Resolución de pantalla: 800 x 3 (RGB) x 480 pixeles
- Fuente de alimentación de 24V
- Conexiones: 2 líneas sin polaridad
- Dimensión: 144(AI) x 244(An) x 23(P)mm
- Unidad externa: Salida de alimentación del bloqueo 12V, 300mA
- Incluye: Monitor, transformador, unidad externa y cable de 10m
- Hasta 4 monitores

Video Intercom features

- 7" color LCD touch screen monitor
- Display resolution: 800 x 3 (RGB) x 480 pixels
- 24V power supply
- Connection: 2 wires without polarity
- Dimension: 144(H) x 244(W) x 23(D)mm
- External station: 12V, 300mA blocking output port
- Includes: Display, transformer, outdoor station and 10m cable
- Up to 4 monitors
- Call log

Videoportero + cerradura eléctrica + Contról remoto / Video intercom + EM Rimlock + Remote control



CITÓFONOS

Audio Intercoms

SKU	DESCRIPCIÓN / DESCRIPTION
0010974	Citofono
0007119	Kit 1 cito 1 frente



Citéfono frente de calle / Audio intercom door station

Características Citéfono

- Comunicación bi direccional e intercomunicación con 2 citófonos adicionales
- Fuente de alimentación 12VDC@1A
- Conexión: 4 hilos (positivo, negativo, audio y datos)

Características Frente de calle

- Resistente a la intemperie y vandalismo IP44
- Luz indicadora
- Capacidad para conectar 1 cerradura eléctrica o cantonera
- Fuente de alimentación 12VDC@1A

Intercom handset features

- Bidirectional communication and intercom with 2 additional intercoms.
- 12VDC power supply @1A.
- Connection: 4-wire (Positive, negative, audio and data).

Door station features

- IP44 Outdoor unit weatherproof and vandalism.
- Indicator light.
- Capacity to connect 1 electromechanical rim lock.
- 12VDC power supply @1A.

2 Citófonos frente de calle / 2 Audio intercom door station



SKU	DESCRIPCIÓN / DESCRIPTION
0007120	Kit 2 cito 1 frente

3 Citófonos frente de calle / 3 Audio intercom door station



SKU	DESCRIPCIÓN / DESCRIPTION
0007121	Kit 3 cito 1 frente

SKU	DESCRIPCIÓN / DESCRIPTION
0007122	Kit 1 cito cerr ele D
0007123	Kit 1 cito cerr ele I
0007124	Kit 1 cito cerr ele dercr
0007125	Kit 1 cito cerr ele izqcr



Citéfono + cerradura eléctrica + Contról remoto /Audio intercom + EM Rimlock+ Remote control



Citéfono + cerradura eléctrica / Audio intercom + EM Rimlock

Características Cerradura eléctrica

- Voltaje de operación: 12V DC
- Para puertas de metal o madera
- Backset de 60mm
- Apertura eléctrica a distancia
- Tres llaves
- Requiere transformador: Entrada: 110V 60Hz 0.06 A max. / 220V 50Hz 0.06 A max. Salida: Min: 12V 60 AC Hz 1.20 A / Max: 12V AC 3A

Características Citéfono

- Comunicación bi direccional e intercomunicación con 2 citófonos adicionales
- Fuente de alimentación 12VDC@1A
- Conexión: 4 hilos (positivo, negativo, audio y datos)

Características Frente de calle

- Resistente a la intemperie y vandalismo IP44
- Luz indicadora
- Capacidad para conectar 1 cerradura eléctrica o cantonera
- Fuente de alimentación 12VDC@1A

EM Rimlock features

- Voltage operation: 12V DC
- For wood or metal doors
- Backset: 60mm
- Electric opening from a remote position
- Three keys
- Transformer required: In: 110V 60Hz 0.06 A max. / 220V 50Hz 0.06 A max. Out: Min: 12V 60 AC Hz 1.20 A / Max: 12V 3A

Intercom handset features

- Bidirectional communication and intercom with 2 additional intercoms.
- 12VDC power supply @1A.
- Connection: 4-wire (Positive, negative, audio and data).

Door station features

- IP44 Outdoor unit weatherproof and vandalism.
- Indicator light.
- Capacity to connect 1 electromechanical rim lock.
- 12VDC power supply @1A.



CAJAS FUERTES

Safes



Caja fuerte electrónica mini / Mini electronic safe

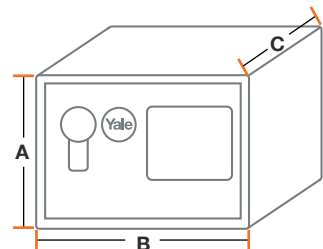

MEDIDAS EN mm. / MEASURES IN mm.		
A	B	C
170	230	170

SKU	DESCRIPCIÓN / DESCRIPTION
0035103	Caja Fuerte Mini Azul
0035104	Caja Fuerte Mini Negra

- Tiene una cerradura electrónica con más de 100.000 combinaciones
 - El botón de reinicio se encuentra en la parte interior
 - Se bloquea temporalmente si se introduce el código erróneo 3 veces
 - Opción de instalación con anclaje en pared y/o piso
 - Construcción en acero con paredes de calibre 16 (1,5mm) y puerta calibre 11 (3mm)
- Has an electronic lock with over 100,000 combinations
 - The reset button is inside the safe
 - It gets blocked temporarily if the wrong code is typed 3 times
 - May be embedded to a wall or floor
 - 16 caliber (1,5mm) steel walls and 11 caliber (3mm) door

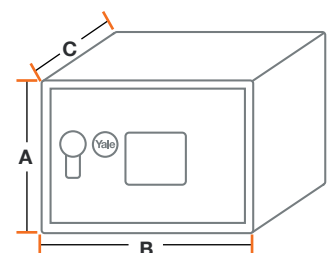

MEDIDAS EN mm. / MEASURES IN mm.		
A	B	C
200	310	200

SKU	DESCRIPCIÓN / DESCRIPTION
0035102	Caja Fuerte Pequeña



Caja fuerte electrónica pequeña / Small electronic safe

- Activación por teclado
 - Botón de reajuste de clave
 - Más de 100.000 combinaciones de claves
 - Indicador de batería baja
 - Apertura con llave Yale
 - Usa 4 baterías AA (incluidas)
 - Orificios para empotrar
 - Construcción en acero con paredes de calibre 16 (1,5mm) y puerta calibre 8 (4mm)
- Simple keypad interface
 - One-touch reset button inside safe
 - Personal code with more than 100,000 combinations
 - Low battery indicator
 - Yale key opening
 - Uses 4 AA batteries (included)
 - Holes to embed
 - Caliber 16 (1.5mm) steel walls and caliber 8 (4mm) steel door



Caja fuerte electrónica mediana / Medium electronic safe

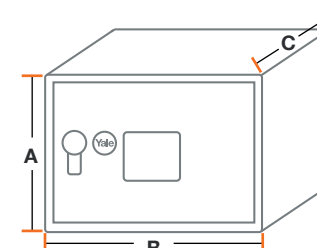

MEDIDAS EN mm. / MEASURES IN mm.		
A	B	C
250	350	250

SKU	DESCRIPCIÓN / DESCRIPTION
0035100	Caja Fuerte Mediana

- Activación por teclado
 - Botón de reajuste de clave
 - Más de 100.000 combinaciones de claves
 - Indicador de batería baja
 - Apertura con llave Yale
 - Usa 4 baterías AA (incluidas)
 - Orificios para empotrar
 - Construcción en acero con paredes de calibre 16 (1,5mm) y puerta calibre 8 (4mm)
- Simple keypad interface
 - One-touch reset button inside safe
 - Personal code with more than 100,000 combinations
 - Low battery indicator
 - Yale key opening
 - Uses 4 AA batteries (included)
 - Holes to embed
 - Caliber 16 (1.5mm) steel walls and caliber 8 (4mm) steel door



Caja fuerte biométrica / Finger print safe

- Activación por huella dactilar, código numérico o llave Yale
 - Registro hasta 30 huellas dactilares
 - Registra 1 código Pins con más de 100.000 combinaciones de claves
 - Botón de reajuste de clave y huellas
 - Indicador de batería baja
 - Usa 4 pilas AA (incluidas)
 - Orificios para anclar a pared y/o piso (tornillos incluidos)
 - Construcción en acero con paredes de calibre 16 (1,5mm) y puerta calibre 8 (4mm)
- Three access credentials: fingerprint, Pins code or Yale key
 - Stores up to 30 fingerprints
 - Registers 1 Pins code with more than 100,000 combinations
 - One-touch reset button inside safe
 - Low battery indicator
 - Uses 4 AA batteries (included)
 - Holes to bolt safe to surface (screws included)
 - Caliber 16 (1.5mm) steel walls and caliber 8 (4mm) steel door

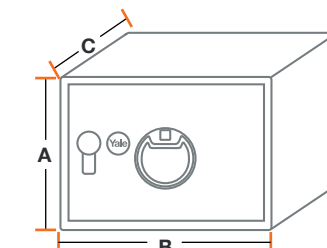

MEDIDAS EN mm. / MEASURES IN mm.		
A	B	C
250	350	300

SKU	DESCRIPCIÓN / DESCRIPTION
0010756	Caja Fuerte Biométrica

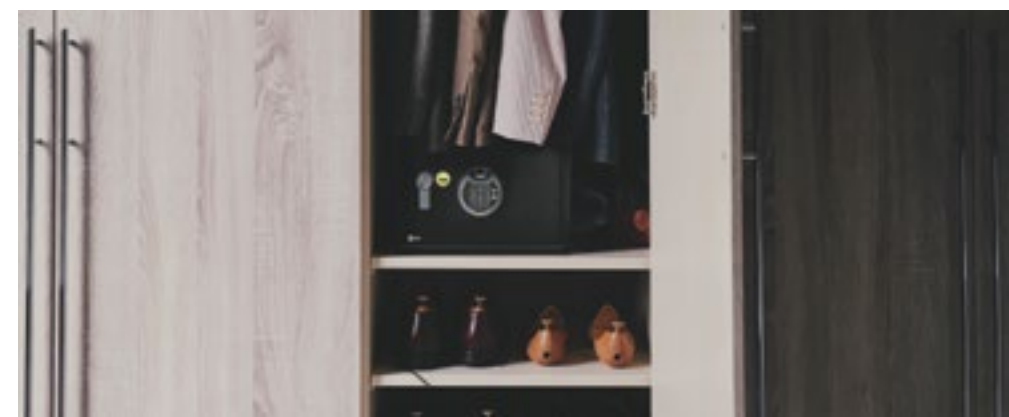



Caja fuerte electrónica laptop / Laptop electronic safe

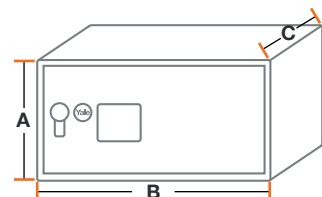

MEDIDAS EN mm. / MEASURES IN mm.

A	B	C
200	430	350

SKU	DESCRIPCIÓN / DESCRIPTION
0035101	Caja Fuerte Laptop

- Activación por teclado
 - Botón de reajuste de clave
 - Más de 100.000 combinaciones de claves
 - Indicador de batería baja
 - Apertura con llave Yale
 - Usa 4 baterías AA (incluidas)
 - Orificios para empotrar
 - Construcción en acero con paredes de calibre 16 (1,5mm) y puerta calibre 8 (4mm)
- Simple keypad interface
 - One-touch reset button inside safe
 - Personal code with more than 100,000 combinations
 - Low battery indicator
 - Yale key opening
 - Uses 4 AA batteries (included)
 - Holes to embed
 - Caliber 16 (1.5mm) steel walls and caliber 8 (4mm) steel door



Caja fuerte hotelera / Hotel electronic safe

- Caja de seguridad con pantalla LED
 - Código de apertura de 3 a 8 dígitos
 - Apertura con código maestro o código de usuario
 - Hasta 105 registros de apertura con código o llave
 - Bulones motorizados
 - Apertura mecánica (2 llaves incluidas)
 - Usa 4 baterías AA (incluidas)
 - 2 años de garantía
- LED screen security box
 - Opening safety code of 3 to 8 digits
 - Master or user code opening capabilities
 - Up to 105 key or code opening logs
 - Automated Bolts
 - Mechanical opening (2 keys included)
 - Uses 4 AA batteries (included)
 - 2 years Guarantee

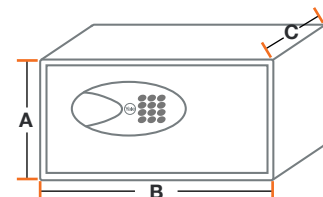

MEDIDAS EN mm. / MEASURES IN mm.

A	B	C
200	430	350

SKU	DESCRIPCIÓN / DESCRIPTION
0035111	Caja Fuerte Hotelera Laptop

CAJAS DE EFECTIVO

Cash boxes



- Estructura en acero
 - Manija para manipular fácilmente
 - Acabado brillante
 - Bandeja plástica para monedas en el interior
 - Cierre con llave (2 incluidas)
- Steel frame
 - Lever for easy manipulation
 - Shiny finish
 - Plastic interior coin tray
 - 2 keys included

Caja de efectivo pequeña / small cash box

MEDIDAS EN mm. / MEASURES IN mm.

A	B	C
80	152	118

SKU	DESCRIPCIÓN / DESCRIPTION
0011309	Caja menor pequeña

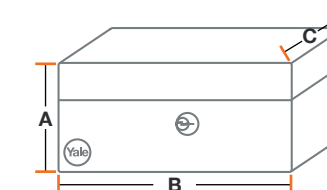

Caja de efectivo mediana / medium cash box

MEDIDAS EN mm. / MEASURES IN mm.

A	B	C
90	200	160

SKU	DESCRIPCIÓN / DESCRIPTION
0011292	Caja menor mediana

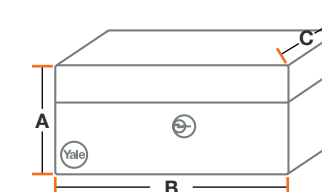

Caja de efectivo grande / big cash box

MEDIDAS EN mm. / MEASURES IN mm.

A	B	C
90	250	180

SKU	DESCRIPCIÓN / DESCRIPTION
0011293	Caja menor grande

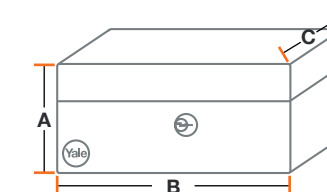

CIRCUITO CERRADO DE TELEVISIÓN CCTV



Kit 1 Yale CCTV 4720P / Yale CCTV 4720P

DVR HD 720p 4 canales

- DVR HD 720p en tiempo real de 4 canales
- Salida de video HDMI / VGA
- Disco duro de 1 TB preinstalado (compatible hasta 4 TB)
- Visión remota vía smartphone / tableta / PC
- Entrada / salida de audio (RCA)
- 2 puertos USB
- Voltaje de funcionamiento 12Vcc/2A

Cámara

- Cámara analoga de alta definición 720p Lente fijo 3.6mm
- Píxeles efectivos: 1280x720p
- Visión nocturna hasta 30m (36pcs LEDs IR)
- Voltaje de funcionamiento 12Vcc / 500MA
- Resistente a la intemperie (Sellamiento IP55)

Incluye

- CCTV 4720P DVR
- Disco duro 1TB (pre-instalado)
- Cámaras 1MP x 4
- Cables BNC de 15m x 4
- Fuentes de poder x 1
- Mouse USB y cable de red
- Tornillo de montaje (cámara)
- Cable HDMI

DVR HD 720p 4 channels

- 4 channels real Time 720p HD DVR
- HDMI/VGA video output
- 1 TB pre-installed HDD (supports up to 4 TB)
- Remote viewing on smartphone / tablet / PC
- Audio input/output (RCA)
- 2 USB ports
- Operating power 12Vcc/2A

Camera

- 720p analog high definition camera
- Effective pixels: 1280x720p
- 30 m infra-red night vision (36pcs LEDs IR)
- Operating power 12Vcc/500MA
- Weatherproof (Sealing IP55)

Includes

- CCTV 4720P DVR
- 1TB hard drive (pre-installed)
- 1MP x 4 cameras
- BNC de 15m x 4 wires
- 1 power source
- USB mouse
- Network cable
- Assembly screw (camera)
- HDMI cable

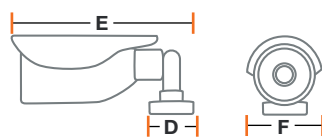
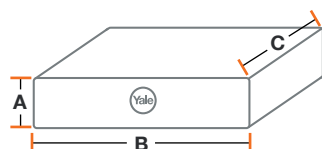

MEDIDAS EN mm. / MEASURES IN mm.

A	B	C	D	E	F
41	255	235	162	60	70

SKU	DESCRIPCIÓN / DESCRIPTION
0010549	Yale CCTV 4CH 4bala 1TB



Kit 2 Yale CCTV 8720P / Yale CCTV 8720P

DVR HD 720p 8 canales

- DVR HD 720p en tiempo real
- 8 canales
- Salida de video HDMI / VGA
- Disco duro de 1 TB preinstalado (compatible hasta 4 TB)
- Visión remota vía smartphone / tableta / PC
- Entrada / salida de audio (RCA)
- 2 puertos USB
- Voltaje de funcionamiento 12Vcc/2A

Cámara

- Cámara bullet de alta definición 720p Lente fijo 3.6mm
- Píxeles efectivos: 1280x720p
- Visión nocturna hasta 30m (36pcs LEDs IR)
- Voltaje de funcionamiento 12Vcc / 500MA conexion via BNC
- Resistente a la intemperie (Sellamiento IP66)

Incluye

- CCTV 8720P DVR
- Disco duro 1TB (pre-instalado)
- Cámaras bullet 1MP x 4 (con posibilidad de ampliar hasta 8 cámaras)
- Cables BNC de 15m x 4
- Fuentes de poder x 4
- Mouse USB
- Cable de red
- Tornillo de montaje (cámara)
- Cable HDMI

DVR HD 720p 8 channels

- Real Time 720p HD DVR
- 8 channels
- HDMI/VGA video output
- 1 TB pre-installed HDD (supports up to 4 TB)
- Remote viewing on smartphone / tablet / PC
- Audio input/output (RCA)
- 2 USB ports
- Operating power 12Vcc/2A

Camera

- 720p analog high definition camera
- Effective pixels: 1280x720p
- 30 m infra-red night vision (36pcs LEDs IR)
- Operating power 12Vcc/500MA
- Weatherproof (Sealing IP66)

Includes

- CCTV 4720P DVR
- 1TB hard drive (pre-installed)
- 1MP x 4 cameras
- BNC de 15m x 4 wires
- 4 power sources
- USB mouse
- Network cable
- Assembly screw (camera)
- HDMI cable

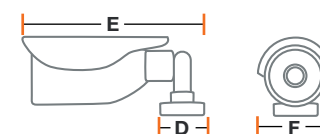
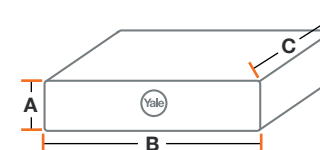

MEDIDAS EN mm. / MEASURES IN mm.

A	B	C	D	E	F
41	255	235	162	60	70

SKU	DESCRIPCIÓN / DESCRIPTION
0010935	Yale CCTV 8CH 4bala 1TB
0010931	Cam CCTV Bala 720p



CON POSIBILIDAD DE AMPLIAR HASTA 8 CÁMARAS / WITH POSSIBLE EXTENSION OF UP TO 8 CAMERAS

**LÁS CAMARAS TAMBIÉN SE VENDEN POR SEPARADO



Kit 3 Yale CCTV 8720P / Yale CCTV 8720P

DVR HD 720p 8 canales

- DVR HD 720p en tiempo real
- 8 canales
- Salida de video HDMI / VGA
- Disco duro de 1 TB preinstalado (compatible hasta 4 TB)
- Visión remota vía smartphone / tableta / PC
- Entrada / salida de audio (RCA)
- 2 puertos USB
- Voltaje de funcionamiento 12Vcc/2A

Cámara

- Cámara domo de alta definición 720p
- Píxeles efectivos: 1280 x 800
- Visión nocturna hasta 20m (24pcs LEDs IR)
- Voltaje de funcionamiento 12Vcc/500mA
- Resistente a la intemperie (Sellamiento IP66)
- Lente fijo de 3.6mm
- Conexión vía BNC

Incluye

- CCTV 8720P DVR
- Disco duro 1TB (pre-instalado)
- Cámaras domo 1MP x 4 (con posibilidad de ampliar hasta 8 cámaras)
- Cables BNC de 15m x 4
- Fuentes de poder x 4
- Mouse USB
- Cable de red
- Tornillo de montaje (cámara)
- Cable HDMI

DVR HD 720p 8 channels

- Real Time 720p HD DVR
- 8 channels
- HDMI/VGA video output
- 1 TB pre-installed HDD (supports up to 4 TB)
- Remote viewing on smartphone / tablet / PC
- Audio input/output (RCA)
- 2 USB ports
- Operating power 12Vcc/2A

Camera

- Dome camera HD 720p
- Effective pixels: 1280 x 800
- Night vision up to 20m (24pcs IR LEDs)
- Operating voltage 12VDC / 500mA
- Weatherproof (IP66 Sealing)
- 3.6mm fixed lens
- BNC connection

Includes

- CCTV 8720P DVR
- 1TB hard drive (pre-installed)
- 1MP x 4 dome cameras (with possible extension up to 8 cameras)
- BNC de 15m x 4 wires
- 4 power sources
- USB mouse
- Network cable
- Assembly screw (camera)
- HDMI cable



****LÁS CAMARAS TAMBIÉN SE VENDEN POR SEPARADO**

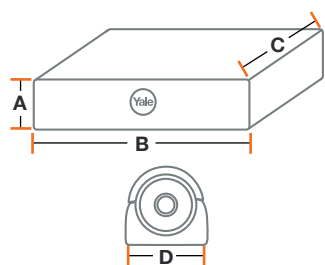

MEDIDAS EN mm. / MEASURES IN mm.

A	B	C	D
41	255	235	70

SKU	DESCRIPCIÓN / DESCRIPTION
0010934	Yale CCTV 8CH 4domo 1TB
0010932	Cam CCTV Domo 720p



CON POSIBILIDAD DE AMPLIAR HASTA 8 CÁMARAS / WITH POSSIBLE EXTENSION OF UP TO 8 CAMERAS

Kit 4 Yale CCTV 8720P / Yale CCTV 8720P

DVR HD 720p 8 canales

- DVR HD 720p en tiempo real
- 8 canales
- Salida de video HDMI / VGA
- Disco duro de 1 TB preinstalado (compatible hasta 4 TB)
- Visión remota vía smartphone / tableta / PC
- Entrada / salida de audio (RCA)
- 2 puertos USB
- Voltaje de funcionamiento 12Vcc/2A

Cámara

- Cámara análoga de alta definición 720p
- Píxeles efectivos: 1280 x 800
- Visión nocturna: Bullet: Hasta 30m (36pcs LEDs IR)
Domo: hasta 20m (24pcs LEDs IR)
- Voltaje de funcionamiento 12Vcc/500mA
- Resistente a la intemperie (Sellamiento IP66)
- Lente fijo 3.6mm
- Conexión vía BNC

Incluye

- CCTV 8720P DVR
- Disco duro 1TB (pre-instalado)
- Cámaras bullet 1MP x 4 - cámaras domo 1MP x 4
- Cables BNC de 15m x 8
- Fuentes de poder x 8
- Mouse USB
- Cable de red
- Tornillo de montaje (cámara)
- Cable HDMI
- Manual de usuario

DVR HD 720p 8 channels

- Real Time 720p HD DVR
- 8 channels
- HDMI/VGA video output
- 1 TB pre-installed HDD (supports up to 4 TB)
- Remote viewing on smartphone / tablet / PC
- Audio input/output (RCA)
- 2 USB ports
- Operating power 12Vcc/2A

Camera

- Analog camera HD 720p
- Effective pixels: 1280 x 800
- Night vision: Bullet up to 30m (36pcs IR LEDs)
Dome: Up to 20m (24pcs IR LEDs)
- Operating voltage 12VDC / 500mA
- Weatherproof (IP66 Sealing)
- 3.6mm fixed lens
- BNC connection

Includes

- CCTV 8720P DVR
- 1TB hard drive (pre-installed)
- 1MP x 4 bullet cameras - 1MP x 4 dome cameras
- BNC de 15m x 4 wires
- 2 power sources
- USB mouse
- Network cable
- Assembly screw (camera)
- HDMI cable
- Users manual



SKU	DESCRIPCIÓN / DESCRIPTION
0010936	Yale CCTV 8Cam 1TB



Yale[®] DIGITAL



Ref: YMF30

Innovación, **seguridad**
y *estilo en sus espacios*

**CERRADURAS
ELÉCTRICAS**
EM Rimlocks



Ref: Cerradura Eléctrica con botón



Las cerraduras electromecánicas son ideales para abrir puertas, portones y rejas de madera o metal a distancia. De esta forma, la comodidad y la seguridad se unen para dar a los hogares y lugares de trabajo la mejor solución en seguridad.

The electromechanical locks are ideal to open wood or metal doors and gates from a remote position. The comfort and security bonds together for a great solution at home or at a light commercial application.

GLOSARIO

Glossary

Características / Features:



En partes mecánicas
On mechanical parts



Opción memoria incluida
Memory included option



Tres llaves
Three keys



Para fácil apertura a distancia
For easy remote opening



Compatible con Yale connect
Yale connect compatible

Abreviatura / Abbreviation:

Cerr elect: Cerradura Electromecánica / Electromechanical Rim Lock

Cant elect: Cantonera Eléctrica / Electric Strike

D: Derecha / Right hand

I: Izquierda / Left hand

Boto: Botón / Button

Memo: Con memoria / With memory

Cort: Placa Corta / Short face plate

Larg: Placa Larga / Long face plate

¿Puerta derecha o izquierda? / Right or left handed door?

¿Cerradura derecha o izquierda?

Desde afuera: si las bisagras están de lado derecho, la cerradura es derecha y si están del lado izquierdo, la cerradura es izquierda.

¿How do you determine if a door is right handed or left handed?

Stand on the outside facing the door. If the hinges are on the left side, you need a left handed lock. If the hinges are on the right hand side, you need a right handed lock.



CERRADURAS ELÉCTRICAS

Electrical rim locks



Cerradura Eléctrica sin botón / No button electrical rim lock

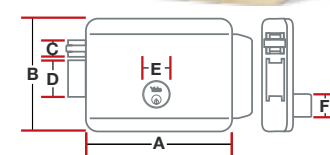

MEDIDAS EN mm. / MEASURES IN mm.					
A	B	C	D	E	F
130	107	20	31	25	16

SKU	DESCRIPCIÓN / DESCRIPTION
0008799	Cerr Elect 60mm I
0008800	Cerr Elect 60mm D

- Voltaje de operación: 12V AC
 - Para puertas de metal o madera
 - Backset: 60mm
 - Apertura eléctrica a distancia
 - Tres llaves
 - Requiere transformador: **Entrada:** 110V 60Hz 0.06 A max. / 220V 50Hz 0.06 A max. **Salida:** Min: 12V AC 60 Hz 1.20 A / Max: 12V AC 3A.
- Voltage operation: 12V AC
 - For wood or metal doors
 - Backset: 60mm
 - Electric opening from a remote position
 - Three keys
 - Transformer required: **In:** 110V 60Hz 0.06 A max. / 220V 50Hz 0.06 A max. **Out:** Min: 12V AC 60 Hz 1.20 A / Max: 12V AC 3A



Cerradura Eléctrica con botón / Electrical rim lock with button

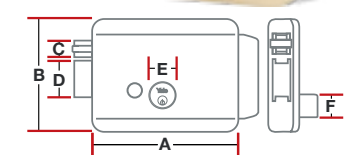

MEDIDAS EN mm. / MEASURES IN mm.					
A	B	C	D	E	F
130	107	20	31	25	16

SKU	DESCRIPCIÓN / DESCRIPTION
0008797	Cerr Elect 60mm I Boto
0008798	Cerr Elect 60mm D Boto

- Voltaje de operación: 12V AC
 - Para puertas de metal o madera
 - Backset: 60mm
 - Apertura eléctrica a distancia y/o con botón pulsador
 - Tres llaves
 - Requiere transformador: **Entrada:** 110V 60Hz 0.06 A max. / 220V 50Hz 0.06 A max. **Salida:** Min: 12V 60 AC Hz 1.20 A / Max: 12V 3A
- Voltage operation: 12V AC
 - For wood or metal doors
 - Backset: 60mm
 - Electric opening from a remote position and/or push button
 - Three keys
 - Transformer required: **In:** 110V 60Hz 0.06 A max. / 220V 50Hz 0.06 A max. **Out:** Min: 12V 60 AC Hz 1.20 A / Max: 12V 3A



Transformador y control remoto / Transformer and remote control



SKU	DESCRIPCIÓN / DESCRIPTION
0010741	Trans 110AC 12V + 2 CR
0010755	Control Remoto Cerr Elect

- Voltaje de entrada: 90 a 250 V AC
- Voltaje de salida: 12V AC
- Potencia: 15 VA
- Puede ser conectada a una batería de respaldo
- Registro hasta 30 Controles Remotos
- Sistema de código variable
- Distancia de operación: 70m
- Voltage input: 90 to 250 V AC
- Voltage output: 12V AC
- Power: 15 VA
- It may be connected to a backup battery
- Up to 30 remote controls
- Rolling code system
- Range: 70 m



CANTONERAS ELÉCTRICAS

Electric strikes

Cantonera corta / Short face plate strike

- Voltaje de operación: 12V AC
- Recomendada para aplicaciones comerciales ligeras que requieren apertura remota
- Compatible con la mayoría de citófonos y videoporteros
- Adecuada para cerraduras de pestillo resbalón
- Para puertas derechas o izquierdas
- Placa frontal en acero
- Con memoria: apertura de puerta con un único pulso eléctrico
- Requiere transformador:
- Entrada: 110V 60Hz 0.06 A max. / 220V 50Hz 0.06 A max.
- Salida: **Min:** 12V AC 1.20A **Max:** 12V AC 3A
- Voltage operation: 12V AC
- Recommended for light comercial applications which require remote opening
- Compatible with most internal phone systems and video intercom
- For use together with a locking device
- For right or left handed doors
- Steel front plate
- With memory: released by a simple electric impulse
- Transformer required
- In: 110V 60Hz 0.06 A max. / 220V 50Hz 0.06 A max.
- Out: **Min:** 12V 1.20 A **Max:** 12V 3 A

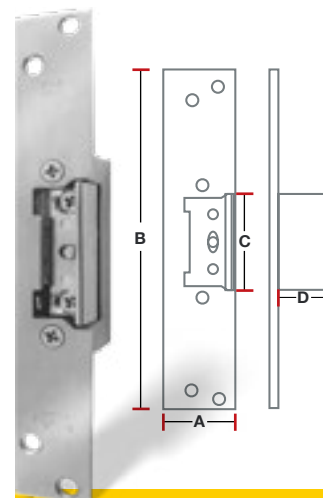

MEDIDAS EN mm. / MEASURES IN mm.				
A	B	C	D	
25	160	47	29	

SKU	DESCRIPCIÓN / DESCRIPTION
0010499	Cant Elect Cort memo 12V

Cantonera larga / Long face plate strike

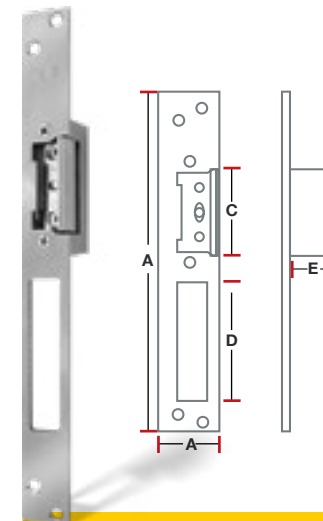

MEDIDAS EN mm. / MEASURES IN mm.				
A	B	C	D	E
25	250	47	74	30

SKU	DESCRIPCIÓN / DESCRIPTION
0010500	Cant Elect Larg memo 12V

- Voltaje de operación: 12V AC
- Recomendada para aplicaciones comerciales ligeras que requieren apertura remota
- Compatible con la mayoría de citófonos y videoporteros
- Adecuada para cerraduras de embutir con pestillo resbalón y pasador
- Para puertas derechas o izquierdas
- Placa frontal en acero
- Con memoria: apertura de puerta con un único pulso eléctrico
- Requiere transformador:
- Entrada: 110V 60Hz 0.06 A max. / 220V 50Hz 0.06 A max.
- Salida: **Min:** 12V AC 1.20A **Max:** 12V AC 3A
- Voltage operation: 12V AC
- Recommended for light comercial applications which require remote opening
- Compatible with most internal phone systems and video intercom
- For use together with a locking device
- For right or left handed doors
- Steel front plate
- With memory: released by a simple electric impulse
- Transformer required
- In: 110V 60Hz 0.06 A max. / 220V 50Hz 0.06 A max.
- Out: **Min:** 12V 1.20 A **Max:** 12V 3 A



PAŞADOR ELÉCTRICO

Electric bolt

Pasador eléctrico / Electric bolt

- Bulón 16mm x 16mm
- Corriente de inicio: 900mA; Reposo: 110mA
- Voltaje: 12VDC
- Temporizador: 0, 3, 6, 9 s
- Salida de señal: NC, COM
- Bloqueado al pasar corriente (Falla segura)
- 1600lb de fuerza de retención
- Probado hasta: 500.000 ciclos
- 16mm x 16mm bolt
- Start current: 900mA; Standby: 110mA
- Voltage: 12VDC
- Time delay: 0, 3, 6, 9 s
- Signal output NC, COM
- Locked when energized (Fail safe electric bolt)
- Holding force 1600lb
- Tested: 500.000 cycles

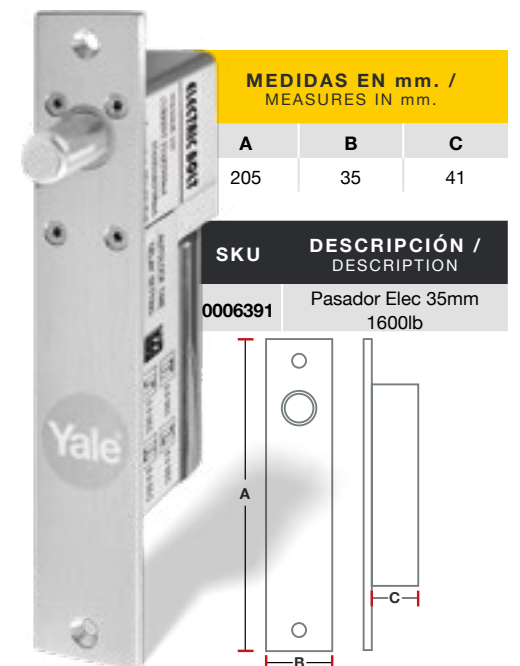

MEDIDAS EN mm. / MEASURES IN mm.		
A	B	C
205	35	41

SKU	DESCRIPCIÓN / DESCRIPTION
0006391	Pasador Elec 35mm 1600lb

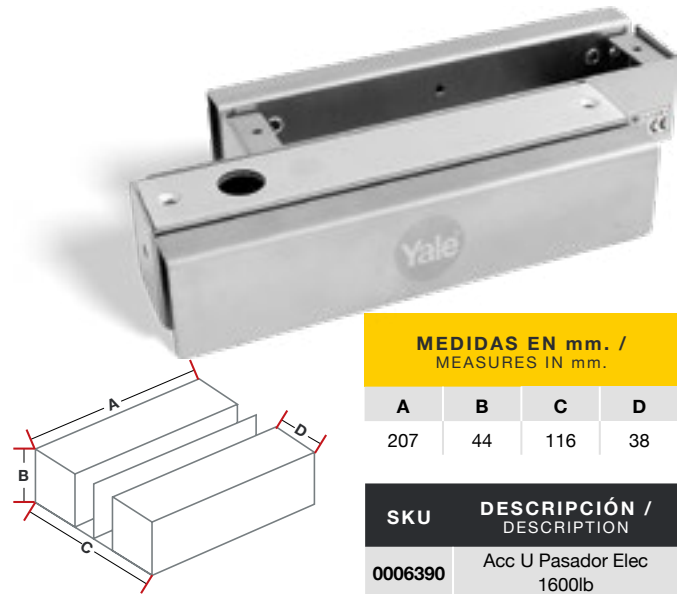

MEDIDAS EN mm. / MEASURES IN mm.			
A	B	C	D
207	44	116	38

SKU	DESCRIPCIÓN / DESCRIPTION
0006390	Acc U Pasador Elec 1600lb

Accesorio "U" para pasador eléctrico / "U" bracket for electric bolt

- No necesita perforación / Does not require any holes
- Para puertas de 10 a 15mm de grosor / For doors 10 to 15mm thick
- Permite apertura a 180° / Allows 180° opening
- Construcción en acero inoxidable / Stainless steel construction
- Compatible con Pasador eléctrico / Electric bolt compatible

KITS ELÉCTRICOS

Electrical kits

Kit cerradura eléctrica / EM strike kit

Cerradura eléctrica + Cable de 10m + Botón + Transformador / EM rimlock + 10m Cable + Button + Transformer



SKU	DESCRIPCIÓN / DESCRIPTION
0010726	Kit Cerr Elect 60mm D
0010727	Kit Cerr Elect 60mm I

SKU	DESCRIPCIÓN / DESCRIPTION
0010790	Kit Cerr Elect D CR
0010791	Kit Cerr Elect I CR

Cerradura eléctrica + Cable de 10m + 2 controles remotos + transformador / EM rimlock + 10m Cable + Remote control + transformer



*El diseño del botón puede variar / *Button design may vary



Kit cantonera eléctrica / Electrical strike kit

Cantonera eléctrica corta o larga + Cable de 10m + Botón + Transformador / Short or long electrical strike + 10m Cable + Button + Transformer

SKU	DESCRIPCIÓN / DESCRIPTION
0010734	Kit Cantele cor memo 12V
0010735	Kit Cantele lar memo 12V

Kit pasador eléctrico / Electric bolt kit

Pasador eléctrico + Botón + Transformador / Electric bolt + Button + Transformer

SKU	DESCRIPCIÓN / DESCRIPTION
0007127	Kit pasador ele 1600lb



Características Kits pasador eléctrico

- Pasador eléctrico 16mm x 16mm
- Voltaje 12VDC
- Temporizador: 0,3,6,9s
- Señal de salida: NC y COM
- 1600Lb de retención

Electric Bolt kits features

- 16mm x 16mm bolt
- Voltage: 12VDC
- Time delay: 0, 3, 6, 9 s
- Signal output NC, COM
- Holding force 1600lb



Kit pasador eléctrico con Accesorio "U" / Electric bolt kit with "U" bracket

Pasador eléctrico + Botón + Transformador + accesorio "U" / Electric bolt + Button + Transformer + "U" bracket

SKU	DESCRIPCIÓN / DESCRIPTION
0007128	Kit pasador ele 1600lb U

ELECTROIMANES

Maglocks



350lb

- Voltaje dual: 12/24 VCD
- Corriente: 12V/300mA - 24V/150mA
- Fuerza de retención: 350lb
- Construcción en zinc y acabado en aluminio anodizado
- Con señal para detectar el estado (bloqueado - desbloqueado), simula sensor de puerta
- Diseño anti residuos magnéticos
- MOV integrado (protege contra corriente en reversa)

- Dual voltage: 12/24 VDC
- Current: 12V/300mA - 24V/150mA
- Clamping force: 350lb
- Zinc built and adonized aluminum cover finish
- Signal to detect state (blocked - unblocked), simulates a door sensor
- Instant release - no residual magnetism
- Integrated MOV (protects against reverse current)



MEDIDAS EN mm. / MEASURES IN mm.

A	B	Profundidad
183	41	20,5

SKU	DESCRIPCIÓN / DESCRIPTION
0009065	Electroimán 350lb

600lb

- Voltaje dual: 12/24 VCD
- Corriente: 12V/500mA - 24V/250mA
- Fuerza de retención: 600lb
- Construcción en zinc y acabado en aluminio anodizado
- Con señal para detectar el estado (bloqueado - desbloqueado), simula sensor de puerta
- Diseño anti residuos magnéticos
- Mantiene el electroimán desactivado por: 0, 3, 6 o 9 segundos
- MOV integrado (protege contra corriente en reversa)

- Dual voltage: 12/24 VDC
- Current: 12V/300mA - 24V/150mA
- Clamping force: 600lb
- Zinc built and adonized aluminum cover finish
- Signal to detect state (blocked - unblocked), simulates a door sensor
- Instant release - no residual magnetism
- Integrated MOV (protects against reverse current)

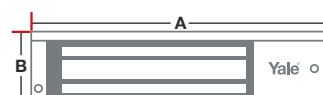

MEDIDAS EN mm. / MEASURES IN mm.

A	B	Profundidad
250	48,5	25

SKU	DESCRIPCIÓN / DESCRIPTION
0009069	Electroimán 600lb



1200lb

- Voltaje dual: 12/24 VCD
- Corriente: 12V/300mA - 24V/150mA
- Fuerza de retención: 1200lb
- Construcción en zinc y acabado en aluminio anodizado
- Con señal para detectar el estado (bloqueado - desbloqueado), simula sensor de puerta
- Diseño anti residuos magnéticos
- MOV integrado (protege contra corriente en reversa)

- Dual voltage: 12/24 VDC
- Current: 12V/300mA - 24V/150mA
- Clamping force: 1200lb
- Zinc built and adonized aluminum cover finish
- Signal to detect state (blocked - unblocked), simulates a door sensor
- Instant release - no residual magnetism
- Integrated MOV (protects against reverse current)

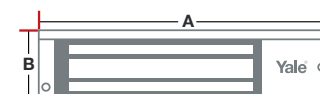

MEDIDAS EN mm. / MEASURES IN mm.

A	B	Profundidad
265	74,8	38,8

SKU	DESCRIPCIÓN / DESCRIPTION
0006741	Electroimán 1200lb

Definición IP68 / IP68 definition

- Protección completa contra contacto
- Protección completa contra penetración de polvo.
- Protección contra la penetración de agua sumergiéndolo por un periodo indefinido.

- Complete protection against contact
- Complete protection against dust penetration
- Complete protection against water penetration by immersing in water for an indefinite amount of time



350lb IP68

- Protección IP 68 para exteriores
- Voltaje dual: 12/24 VCD
- Corriente: 12V/300mA - 24V/150mA
- Fuerza de retención: 180 Kg (350lb)
- Construcción en zinc y acabado en aluminio anodizado
- Con señal para detectar el estado (bloqueado - desbloqueado), simula sensor de puerta
- Diseño anti residuos magnéticos
- MOV integrado (protege contra corriente en reversa)

- IP 68 outdoor protection
- Dual voltage: 12/24 VDC
- Current: 12V/300mA - 24V/150mA
- Clamping force: 350lb
- Zinc built and adonized aluminum cover finish
- Signal to detect state (blocked - unblocked), simulates a door sensor
- Instant release - no residual magnetism
- Integrated MOV (protects against reverse current)

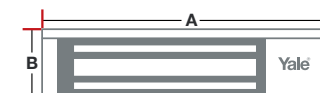

MEDIDAS EN mm. / MEASURES IN mm.

A	B	Profundidad
183	41	20,5

SKU	DESCRIPCIÓN / DESCRIPTION
0009111	Electroiman 350 exterior

600lb IP68

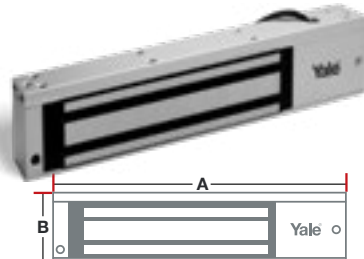

MEDIDAS EN mm. / MEASURES IN mm.		
A	B	Profundidad
183	41	20,5

SKU	DESCRIPCIÓN / DESCRIPTION
0009113	Electroiman 600 exterior

- Protección IP 68 para exteriores
- Voltaje dual: 12/24 VCD
- Corriente: 12V/500mA - 24V/250mA
- Fuerza de retención: 600lb
- Construcción en zinc y acabado en aluminio anodizado
- Con señal para detectar el estado (bloqueado - desbloqueado), simula sensor de puerta
- Diseño anti residuos magnéticos
- Mantiene el electroimán desactivado por: 0, 3, 6 o 9 segundos
- MOV integrado (protege contra corriente en reversa)

- IP 68 outdoor protection
- Dual voltage: 12/24 VDC
- Current: 12V/300mA - 24V/150mA
- Clamping force: 600lb
- Zinc built and adonized aluminum cover finish
- Signal to detect state (blocked - unblocked), simulates a door sensor
- Instant release - no residual magnetism
- Integrated MOV (protects against reverse current)



350lb embutir / 350lb mortise

- Voltaje dual: 12/24 VCD
- Corriente: 12V/300mA - 24V/150mA
- Fuerza de retención: 350lb
- Construcción en zinc y acabado en aluminio anodizado
- Con señal para detectar el estado (bloqueado - desbloqueado), simula sensor de puerta
- Diseño anti residuos magnéticos
- MOV integrado (protege contra corriente en reversa)

- Dual voltage: 12/24 VDC
- Current: 12V/300mA - 24V/150mA
- Clamping force: 350lb
- Zinc built and adonized aluminum cover finish
- Signal to detect state (blocked - unblocked), simulates a door sensor
- Instant release - no residual magnetism
- Integrated MOV (protects against reverse current)

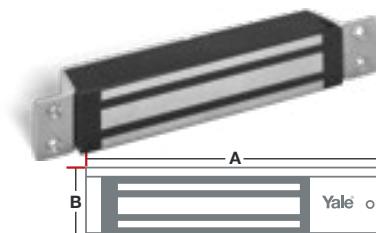

MEDIDAS EN mm. / MEASURES IN mm.		
A	B	Profundidad
190	32	22

SKU	DESCRIPCIÓN / DESCRIPTION
0006744	Electroimán 350lb emb

600lb / 600lb mortise

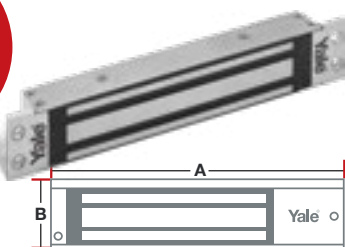

MEDIDAS EN mm. / MEASURES IN mm.		
A	B	Profundidad
232	42	24,5

SKU	DESCRIPCIÓN / DESCRIPTION
0006740	Electroimán 600lb emb

- Voltaje dual: 12/24 VCD
- Corriente: 12V/300mA - 24V/150mA
- Fuerza de retención: 600lb
- Construcción en zinc y acabado en aluminio anodizado
- Con señal para detectar el estado (bloqueado - desbloqueado), simula sensor de puerta
- Diseño anti residuos magnéticos
- MOV integrado (protege contra corriente en reversa)

- Dual voltage: 12/24 VDC
- Current: 12V/300mA - 24V/150mA
- Clamping force: 600lb
- Zinc built and adonized aluminum cover finish
- Signal to detect state (blocked - unblocked), simulates a door sensor
- Instant release - no residual magnetism
- Integrated MOV (protects against reverse current)



KITS ELÉCTROIMANES

Maglock kits

Electroimán 350, 600 o 1200lb + Accesorio "U", "L" o "ZL" / 350, 600 or 1200lb maglock + "U", "L" or "ZL" Bracket

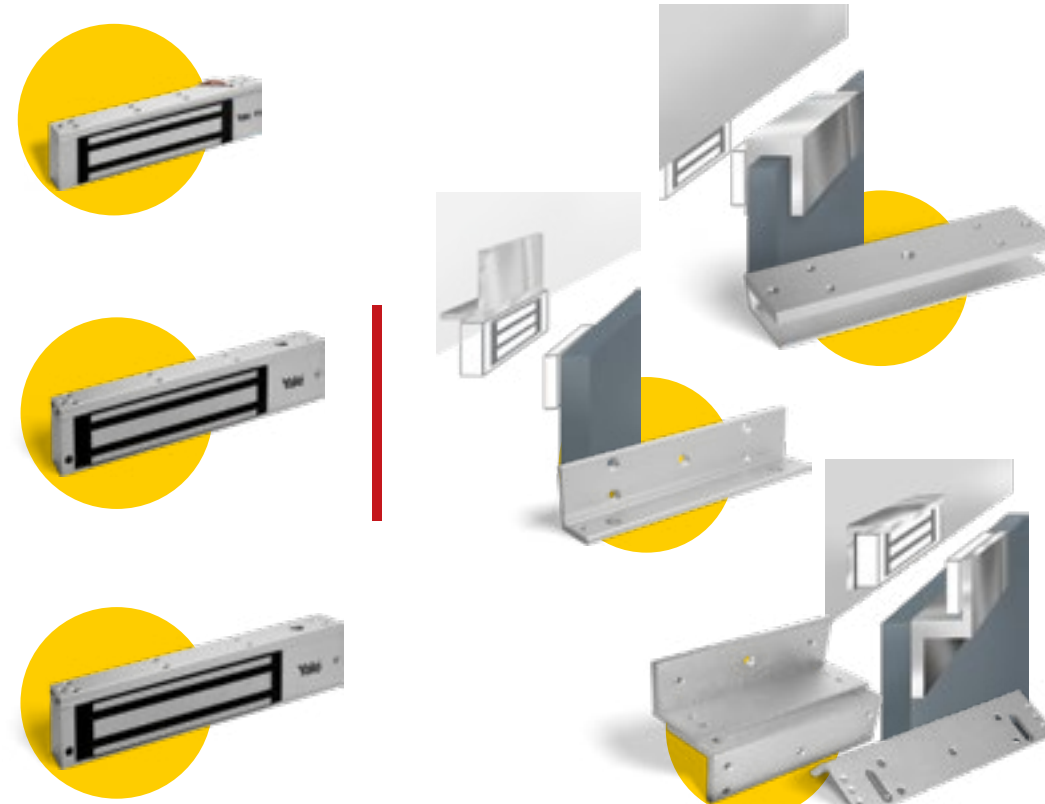

Accesorio U

SKU	DESCRIPCIÓN / DESCRIPTION
0007028	Electroiman 350 ACC U
0007033	Electroiman 600 ACC U

Accesorio L

SKU	DESCRIPCIÓN / DESCRIPTION
0007030	Electroiman 350 ACC L
0007032	Electroiman 600 ACC L
0006742	Electroiman 1200 ACC L

Accesorio ZL

SKU	DESCRIPCIÓN / DESCRIPTION
0007029	Electroiman 350 ACC ZL
0007031	Electroiman 600 ACC ZL
0006743	Electroiman 1200 ACC ZL

Electroimán 350, 600, 350 o 600lb embutir + Botón + Buzzer + Transformador / 350, 600 or 1200lb maglock + Button + Buzzer + Transformer

SKU	DESCRIPCIÓN / DESCRIPTION
0006673	Kit Electroiman 350lb
0006674	Kit Electroiman 600lb
0006723	Kit Electroiman 350lb Ext
0006716	Kit Electroiman 600lb Ext
0006729	Kit Electroiman 350lb emb
0006725	Kit Electroiman 600lb emb



Electroimán 350, 600, 1200, 350 o 600lb exterior + Accesorio en “U”, “L” o “ZL”+ Botón + Buzzer + Transformador / 350, 600 or 1200lb maglock + “U”, “L” or “ZL” Bracket + Button + Buzzer + Transformer

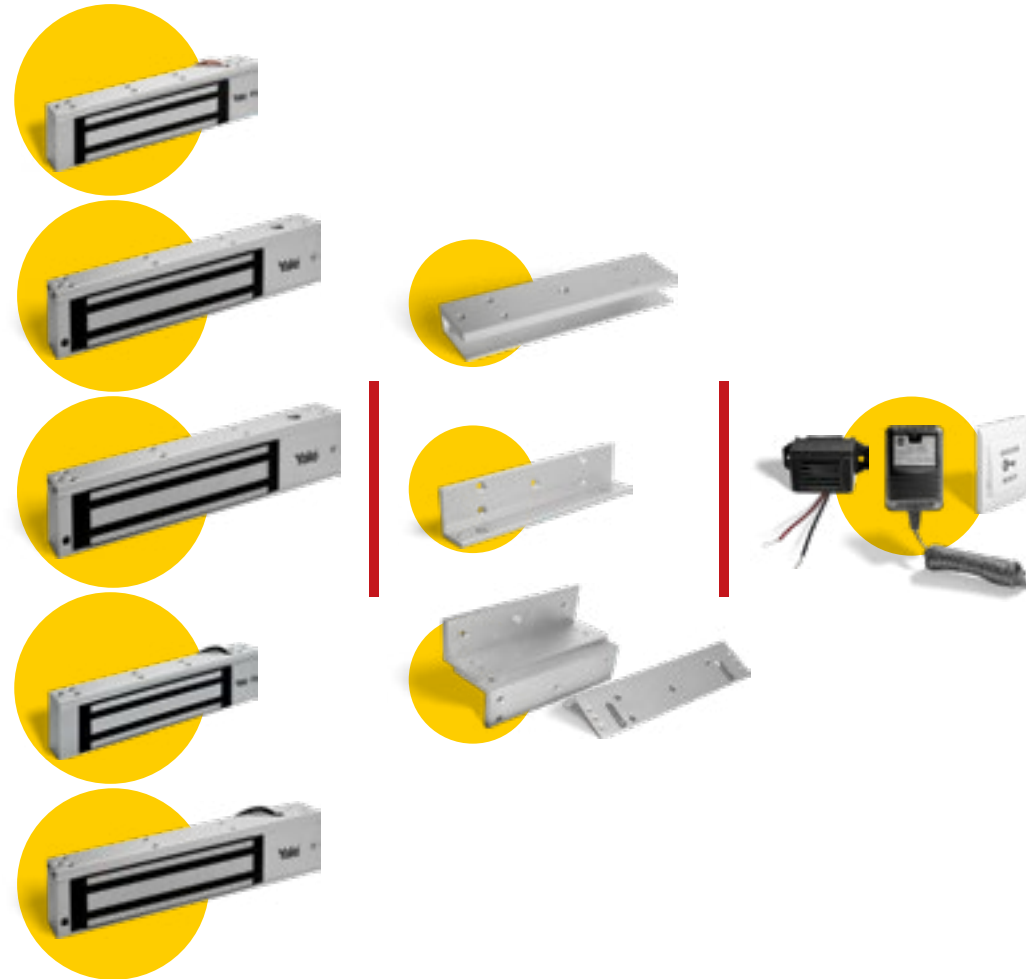

Accesorio U

SKU	DESCRIPCIÓN / DESCRIPTION
0006671	Kit Electroiman 350 U
0006667	Kit Electroiman 600 U
0006722	Kit Electroiman 350 Ext U
0006717	Kit Electroiman 600 Ext U

Accesorio L

SKU	DESCRIPCIÓN / DESCRIPTION
0006670	Kit Electroiman 350 L
0006669	Kit Electroiman 600 L
0006727	Kit Electroiman 1200 L
0006718	Kit Electroiman 350 Ext L
0006721	Kit Electroiman 600 Ext L

Accesorio ZL

SKU	DESCRIPCIÓN / DESCRIPTION
0006672	Kit Electroiman 350 ZL
0006668	kit Electroiman 600 ZL
0006724	Kit Electroiman 1200 ZL
0006719	Kit Electroiman 350 Ext ZL
0006720	kit Electroiman 600 Ext ZL

Electroimán 350 o 600lb + Accesorio en “U”, o “ZL”+ Botón no touch + Teclado + Transformador / 350 or 600lb maglock + “U” or “ZL” Bracket + No touch Button + Keyboard + Transformer

SKU	DESCRIPCIÓN / DESCRIPTION
0010957	Kit Eleiman 350 U BTN T
0010958	Kit Eleiman 600 U BTN T
0010959	Kit Eleiman 350 ZL BTN T
0010960	Kit Eleiman 600 ZL BTN T



Electroimán 350 o 600lb + Botón + Buzzer + Transformador + Contról remoto / 350 or 600lb maglock + Button + Buzzer + Transformer + Remote control



SKU	DESCRIPCIÓN / DESCRIPTION
0006699	Kit Electroiman 350 CR
0006698	Kit Electroiman 600 CR

Electroimán 350, 600 o 1200lb + Accesorio en “U”, “L” o “ZL”+ Botón + Buzzer + Transformador + Contról Remoto / 350 or LED 600lb maglock + “U”, “L” or “ZL” Bracket + Button + Buzzer + Transformer + Remote control

Accesorio U

SKU	DESCRIPCIÓN / DESCRIPTION
0007040	Kit Electroiman 350 CR+U
0007043	Kit Electroiman 600 CR+U

Accesorio L

SKU	DESCRIPCIÓN / DESCRIPTION
0007039	Kit Electroiman 350 CR+L
0007042	Kit Electroiman 600 CR+L
0006726	Kit Electroiman 1200 CR+L

Accesorio ZL

SKU	DESCRIPCIÓN / DESCRIPTION
0007041	Kit Electroiman 350 CR+ZL
0007044	Kit Electroiman 600 CR+ZL
0006728	Kit Electroiman 1200 CR+ZL

Accesorios individuales / Individual Brackets

350lb		600lb		1200lb	
SKU	DESCRIPCIÓN / DESCRIPTION	SKU	DESCRIPCIÓN / DESCRIPTION	SKU	DESCRIPCIÓN / DESCRIPTION
0009068	Acc U Electroiman 350lb	0009070	Acc U Electroiman 600lb	0006742	Acc L Electroiman 1200
0009067	Acc L Electroiman 350lb	0009071	Acc L Electroiman 600lb	0006743	Acc ZL Electroiman 1200
0009066	Acc ZL Electroiman 350lb	0009072	Acc ZL Electroiman 600lb		

ACCESORIOS

Accessories

Módulo control remoto / Remote control module



SKU	DESCRIPCIÓN / DESCRIPTION
0006697	Modulo Remoto+1Control
0006701	Control Remoto x3

- Voltaje de entrada: 12V DC DC
- Hasta 29 controles remoto
- Contactos de salida: NO/NC/COM
- Distancia de operación: 50m en espacio abierto
- Frecuencia de operación: 433.92MHz
- Voltage operation: 12V DC DC
- Up to 29 remote controls
- Exit contacts: NO/NC/COM
- Operating range: 50m in open field
- Operating frequency: 433.92 MHz

Teclado de control de acceso / Access control keyboard

- 250 usuarios clave / tarjeta
- Fácil programación e instalación
- Operación con uno o múltiples códigos de usuario
- Bloqueo por 30 segundos después de introducir 10 códigos incorrectos
- Botón de timbre
- 250 users code / card
- Easy programming and installation
- Operation with one or multiple user codes
- Lock for 30 seconds after entering 10 incorrect codes
- Doorbell button



SKU	DESCRIPCIÓN / DESCRIPTION
0010955	Teclado Control Acceso

Tarjetas de proximidad / Proximity cards



SKU	DESCRIPCIÓN / DESCRIPTION
0007107	Tarjeta prox 125khz

- Tarjeta inteligente sin contacto
- Frecuencia: 125KHz
- Distancia de lectura: 10cm
- Tarjeta blanca para impresión directa por las 2 caras
- Permite perforación vertical y horizontal para portar como carné
- Compatible con teclado Yale
- Contactless smart card
- Frequency: 1125KHz
- Read distance: 10cm
- Blank card for direct printing of both faces
- Vertical and horizontal perforation allowed
- Compatible with Yale keyboard

Botón hongo / Output Button

- 3 contactos de salida NC, C y NA
- Acero inoxidable
- 3 contacts output NC, C and NA
- Stainless steel

SKU	DESCRIPCIÓN / DESCRIPTION
0007054	Boton hongo salida



SKU	DESCRIPCIÓN / DESCRIPTION
0007055	Boton no touch salida



Botón no touch / No Touch Button

- 3 contactos de salida NC, C y NA
- Acero inoxidable
- 3 contacts output NC, C and NA
- Stainless steel

Gabinete fuente cargadora / Proximity cards

- Batería mantiene el voltaje constante y estable
- LEDs indicadores del funcionamiento del equipo
- Protección de batería en caso de falla o bajo voltaje
- Voltaje de entrada: 110VAC
- Voltaje de salida 12VDC 3A
- Productos compatibles: Electroimanes y pasador eléctrico
- *no incluye batería
Baterías recomendadas: 12V5AH - 12V7A
- It maintains a constant and stable voltage
- LED indicators to show its functioning
- Battery protection in case of failure or low voltage
- Voltage operation: 110VAC
- Out Voltage: 12VDC 3A
- Compatible with Maglock and Electric Bolt
- *Battery not included
Recommended Battery: 12V5AH - 12V7A



SKU	DESCRIPCIÓN / DESCRIPTION
0009112	Gab fte carg bat eleiman
0009145	Fuente + Batería Eleiman



Sistema de control de acceso

El SBOX es un servidor Linux de control de acceso que puede controlar hasta 10 puertas y monitorear y grabar un máximo de 24 cámaras IP (Onvif). Un servidor Plug & Play destinado especialmente minorista, convierte la instalación, configuración y operación del control de acceso en algo simple y práctico.

Para pequeñas aplicaciones

Un sistema profesional y sofisticado que entrega al mercado de pequeñas y medianas empresas una solución integrada de seguridad.



PLUG&PLAY



CMS PARA GESTIÓN DE CÁMARAS DE DIFERENTES SITIOS Y MONITOREO CENTRAL



AUTORIZADO PARA 24 CÁMARAS IP ONVIF



AUTORIZADO PARA UN MÁXIMO 10 PUERTAS



FLEXIBLE, SIMPLE Y POTENTE



SALIDA DE MONITOR HDMI Y VGA

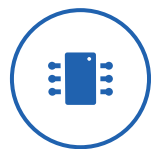

PARA USO CON CONTROLADORAS SCAIIP DE 2 PUERTAS



INTERFAZ WEB PARA CONTROL DE ACCESO



INTEGRACIÓN DE CONTROL DE ACCESO + VIDEO



Aplicación de acceso



Aplicación de vídeo



APLICACIONES

OFICINAS

CONDOMINIOS

ESCUELAS

CONSULTORIOS

TIENDAS Y MINORISTAS

SISTEMAS DE CONTROL DE ACCESO PARA MEDIANAS Y GRANDES APLICACIONES

PUERTA

Controla el acceso hasta de dos puertas, alimentando todo el sistema, incluso cerraduras y lectores de proximidad.



PUERTA PoE

Controla el acceso hasta de dos puertas, alimentando todo el sistema, incluso cerraduras y lectores de proximidad (HiPoE).



ALARMA

Controla el acceso de una puerta y 32 entradas de alarma supervisadas.



ESTACIONAMIENTO

Controla el acceso de 2 barreras de autos, permitiendo la instalación de bucle de masa.



MOLINETES

Controla el acceso de giro y pictograma.



ELEVADOR

Controla 64 pisos.



RACK

Controla acceso de 16 puertas de rack, monitoreando apertura de todas las puertas.

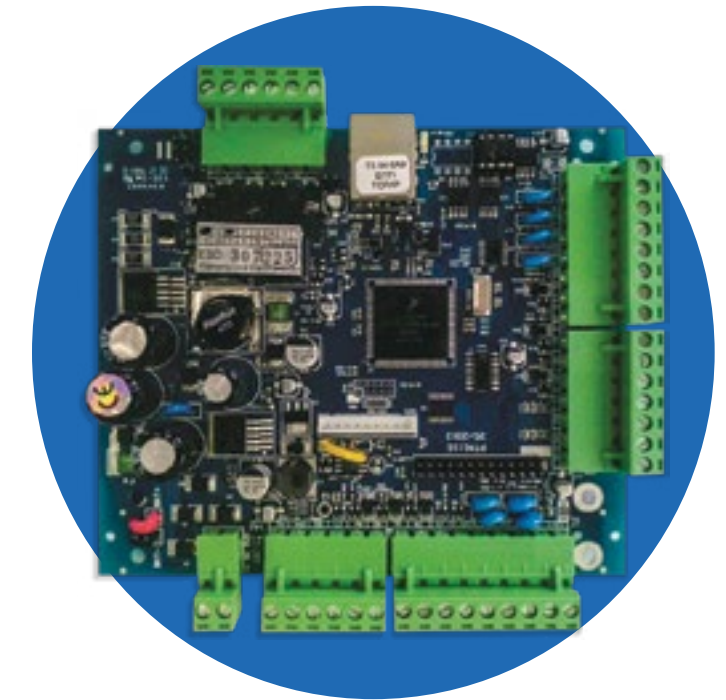

DIFERENCIAS DE LAS CONTROLADORAS

- FUENTE DE ENERGÍA INCORPORADA**
Circuito integrado de fuente de energía con cargador de batería de backup.
- AUTONOMÍA**
Capaz de alimentar todos los dispositivos conectados a ella.
- OPCIÓN SISTEMA DE ALIMENTACIÓN POE**
Única controladora PoE en el mundo capaz de alimentar 4 lectores y 2 cerraduras directamente
- MONITOREO DE ENERGÍA CA/CC**, alerta al operador del software en caso de cualquier problema.
- TCP/IP NATIVO**
La velocidad de comunicación de datos es inmensamente mayor y más confiable que la de un sistema serial tradicional

- ANCHO DE BANDA AJUSTABLE**
Transmisión de datos a alta velocidad y en tiempo real con bajo consumo de ancho de banda.
- FLEXIBILIDAD DE INSTALACIÓN**
Ideal para ser utilizado dentro de la infraestructura de R existente.
- AMBIENTE CLIENTE X SERVIDOR**
La comunicación entre el servidor de aplicaciones y las controladoras ocurre únicamente cuando hay un evento nuevo que ha de ser enviado.
- COMUNICACIÓN PUNTO A PUNTO**
No es necesario que el servidor esté online para que las controladoras se comuniquen entre sí.
- ALGORITMO PATENTADO**
Garantiza la búsqueda de una tarjeta válida o no válida en menos de un segundo.

SCAIPWEB PRO

Es el módulo de software para un servidor de control de acceso local, que se utiliza normalmente para aplicaciones de un único sitio.

Dispone de diversos recursos como integración con sistemas de CCTV, control de elevadores, sensores de intrusión, sistemas de detección de incendio, sistema de control y registro de visitantes (VMS), prerregistro de visitantes, entre otros.

Funciona en conjunto con las controladoras, alimentándolas con las reglas de negocios y recibiendo sus transacciones.

VAULT ENTERPRISE

El sistema de control de acceso VAULT ENTERPRISE se desarrolló para atender aplicaciones de gran tamaño. Está destinado a proyectos multisitios, en los que el usuario del sistema posee varias plantas y quiere controlar todos sus sitios de manera centralizada

VAULT ENTERPRISE SITE

Es el módulo de software para un servidor de control de acceso local de uno de los sitios.

Dispone de diversos recursos como integración con sistemas de CCTV, control de elevadores, sensores de intrusión, sistemas de detección de incendio, sistema de control y registro de visitantes (VMS), prerregistro de visitantes, entre otros.

Funciona en conjunto con las controladoras, alimentándolas con las reglas de negocios y recibiendo sus transacciones.

VAULT ENTERPRISE CENTRAL

Centralizar y gestionar toda la información de todos los sitios. Puede segmentar los privilegios de acceso e informes de estos sitios, independientemente uno del otro.

VAULT ENTERPRISE SITE también se comunica con el módulo VAULT ENTERPRISE CENTRAL, actualizando y haciendo redundancia de su base de datos, incrementa considerablemente la seguridad e integridad del sistema.

Recibe la transacciones de todos los servidores con el VAULT ENTERPRISE SITE y organiza en su base de datos central.

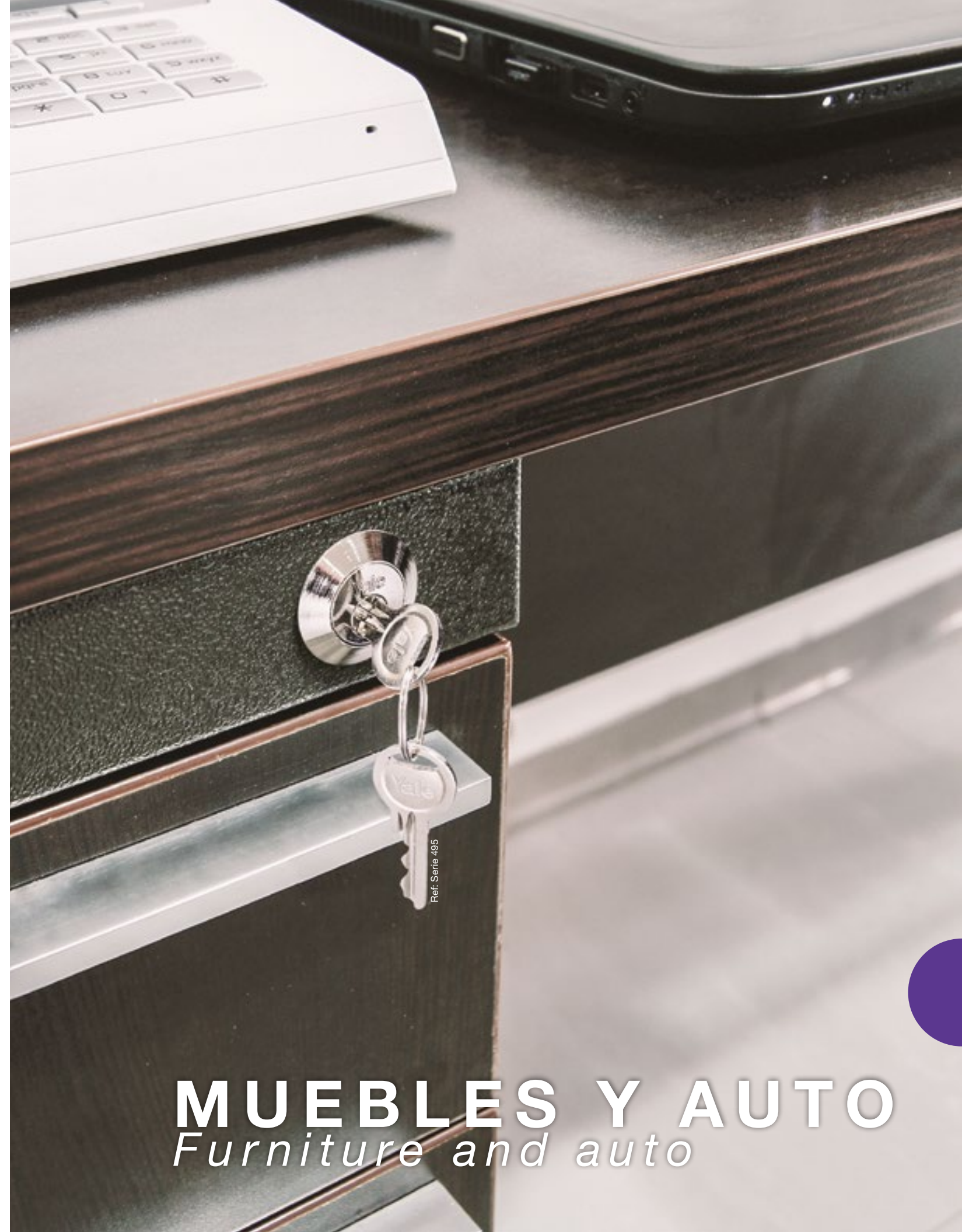
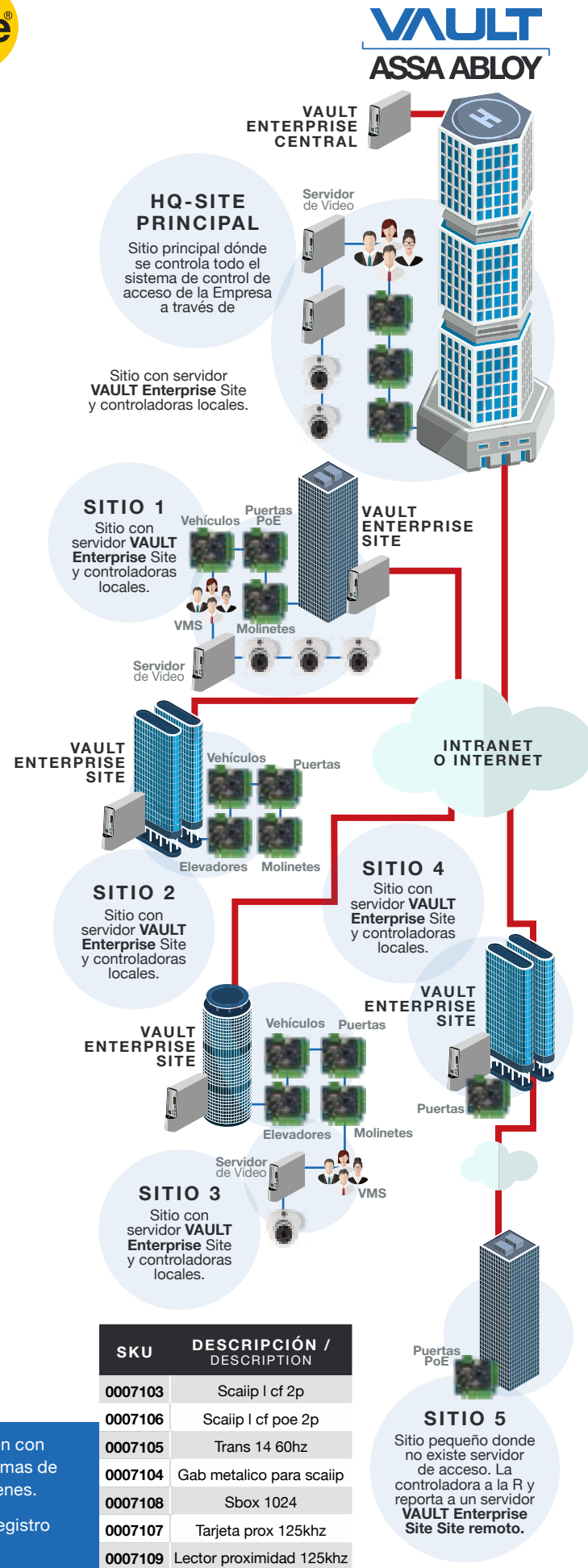

MUEBLES Y AUTO
Furniture and auto

- Diferenciales de **VAULT ASSA ABLOY**
- Plataforma de Control de Acceso WEB de gran tamaño, IP nativo.
- Sistema de registro de visitantes.
- Posee integración con diversas plataformas de manejo de imágenes.
- Módulo de prerregistro web.



Las cerraduras para muebles y autos de Yale cuentan con una gran variedad de diseños y acabados que se adaptan perfectamente a muebles, cajones, escritorios, puertas correderas y distintos tipos de automóviles.

Entre las características de las cerraduras se destaca el cilindro en latón gracias a su mayor durabilidad.

The furniture and auto locks from Yale comes with a wide variety of designs and finishes that adapts perfectly to furniture, drawers, desks, overlap sliding doors and different types of automobiles.

Among the features of the locks, the brass cylinder stands out given to its durability.

GLOSARIO

Glossary

Acabados / Finishes:



US3
Latón
brillante /
Bright brass



US14
Níquel
brillante /
Bright nickel



US26D
Cromo
satinado /
Satin chrome

Características / Features:



Instalación sencilla
Easy installation



4 pines
4 pins



5 pines
5 pins

Abreviatura / Abbreviation:

C: Caja
/ Box

I: Izquierda
/ Left Handed

D: Derecha
/ Right Handed

A: Una unidad
/ One unit

A2: Igualado X2
/ Key alike X2

A3: Igualado X3
/ Key alike X3

¿PROFESIONAL O ESTÁNDAR?

Professional or standar?

Ahora Yale ofrece un portafolio de cerraduras de mueble más amplio, adaptándose a cada necesidad con la garantía de siempre.

La Línea Profesional está creada para muebles que requieren mayor seguridad, gracias a sus sistema de pines o guardas y a sus materiales de mayor resistencia y duración. Estas características brindan, por ejemplo, un menor número de repeticiones de

las llaves, lo que las hace ideales para lockers de universidades, colegios u oficinas entre otros usos. La Línea Estándar brinda la tranquilidad que usted necesita para mantener sus objetos protegidos a un precio accequible, ofreciendo un portafolio con soluciones para esos espacios de uso constante.

Con este portafolio usted podrá acceder a la seguridad de Yale, la marca que protege su hogar también cuida sus objetos más preciados.



LÍNEA PROFESIONAL

Professional line

Mayor calidad y seguridad para sus muebles /
Better quality and security for your furniture

Serie F6700 / F6700 series

- Cerrojo de acero de acción vertical
- 5 pines
- Para cajones, muebles y escritorios
- 2 llaves
- Upright action Steel bolt
- 5 pins
- For drawers, furniture and desks
- 2 keys

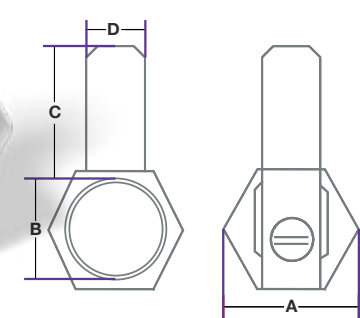

MEDIDAS EN mm. / MEASURES IN mm.			
A	B	C	D
25,6	13	25,4	16

SKU	DESCRIPCIÓN / DESCRIPTION
0005012	Mueble F6700 US14
0005018	Mueble F6700 US14 B

Serie 495-25 / 495-25 series

- Cerrojo tipo gancho de acción giratoria
- 5 pines
- Para cajones, muebles y escritorios
- 2 llaves referencia "A"
- 3 llaves referencias "A2" y "A3"
- Rotating action Hook bolt
- 5 pins
- For drawers, furniture and desks
- 2 keys for "A" reference
- 3 keys for "A2" and "A3" references

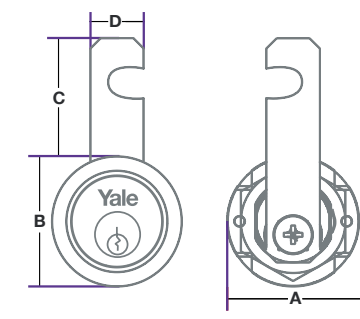

SKU	DESCRIPCIÓN / DESCRIPTION
0005024	Mueble 495 25A US14
0005025	Mueble 495 25A2 US14
0005026	Mueble 495 25A3 US14

MEDIDAS EN mm. / MEASURES IN mm.			
A	B	C	D
25,6	13	31,7	16,5





Serie 2044 / 2044 series

- Pestillo de acción vertical
- 4 pines
- Longitud del cilindro: 27 o 40mm según referencia
- Backset 20mm
- Para armarios y/o escritorios
- Cuerpo zincado
- Upright action bolt
- Vertical latch
- Cylinder length: 27 or 40mm depending on reference
- Backset 20mm
- For lockers and / or desks
- Zinc plated body

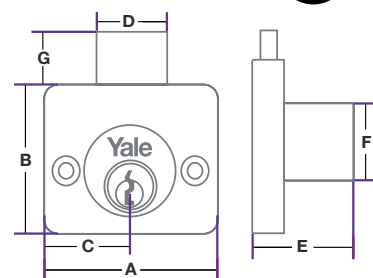

SKU	DESCRIPCIÓN / DESCRIPTION
0005007	Mueble 2044 corta US14
0005009	Mueble 2044 larga US14
0005014	Mueble 2044 corta US14B

MEDIDAS EN mm. / MEASURES IN mm.						
A	B	C	D	E	F	G
45	38	20	18	27/40	22	13

Serie 2045 / 2045 series

- Pestillo de acción vertical
- 4 pines
- Pestillo horizontal
- Longitud del cilindro: 27 o 40mm según referencia
- Backset 20mm
- Para armarios y/o escritorios
- Cuerpo zincado
- Upright action bolt
- 4 pins
- Horizontal latch
- Cylinder length: 27 or 40mm depending on reference
- Backset 20mm
- For lockers and / or desks
- Zinc plated body

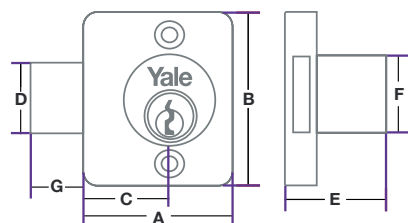

MEDIDAS EN mm. / MEASURES IN mm.						
A	B	C	D	E	F	G
30	45	20	18	27/40	22	13

SKU	DESCRIPCIÓN / DESCRIPTION
0005008	Mueble 2045 corta US14
0005010	Mueble 2045 larga US14



Serie 500 / 500 series

- Cerrojo de acero de acción vertical
- 4 pines
- Para cajones, muebles y escritorios
- 2 llaves
- Steel deadbolt lock
- 4 pins
- For drawers, furniture and desks
- 2 keys

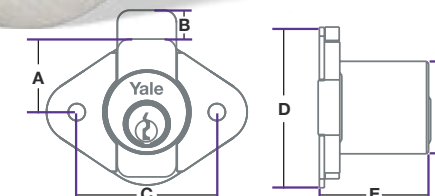

MEDIDAS EN mm. / MEASURES IN mm.					
A	B	C	D	E	F
19,3	7,6	37	36	26,2	22,2

SKU	DESCRIPCIÓN / DESCRIPTION
0005150	Mueble 500 US26D

Serie 510 / 510 series

- Cerrojo tipo botón, cierra al presionar
- 4 pines
- Para puertas correderas de traslape
- Para bastones antirrobo para automóvil
- Para muebles metálicos y de madera
- 2 llaves
- Deadbolt lock with button
- 4 pins
- For overlap sliding doors
- For steering wheel locks
- Metal and wooden furniture
- 2 keys

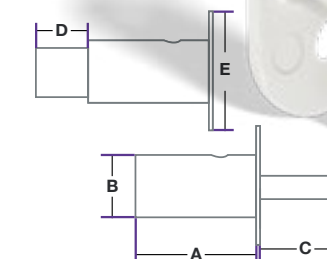
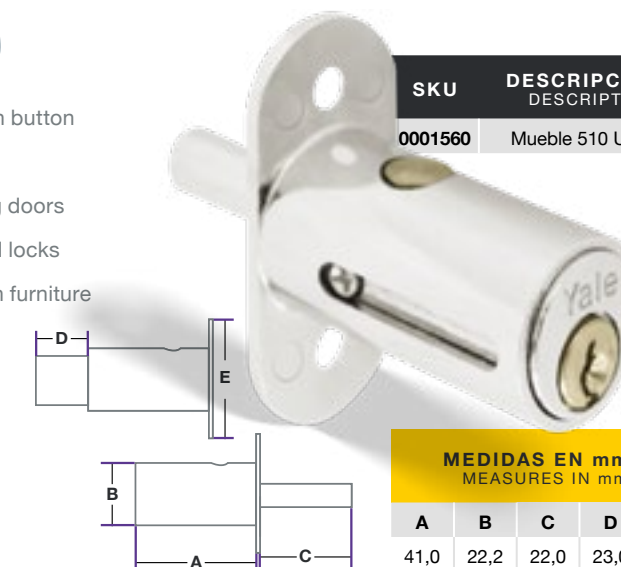

SKU	DESCRIPCIÓN / DESCRIPTION
0001560	Mueble 510 US26D

MEDIDAS EN mm. / MEASURES IN mm.				
A	B	C	D	E
41,0	22,2	22,0	23,0	33,2

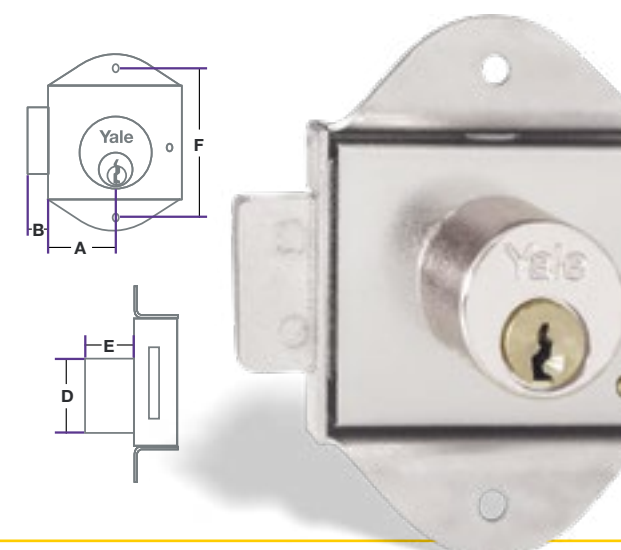

Serie 520 / 520 series

- Cerrojo de acción horizontal
- 4 pines
- Cilindro en latón
- 2 llaves
- Horizontal steel bolt lock
- 4 pins
- Brass cylinder
- 2 keys



MEDIDAS EN mm. / MEASURES IN mm.				
A	B	C	D	E
23,7	9,2	55,7	22,2	16,3

SKU	DESCRIPCIÓN / DESCRIPTION
0010595	Mueble 520 US26D



Serie 530 / 530 series

- Para muebles de oficina
 - 4 pines
 - Cilindro en latón
 - 2 llaves
- For office furniture
 - 4 pins
 - Brass cylinder
 - 2 keys

SKU	DESCRIPCIÓN / DESCRIPTION
0010594	Mueble 530 US26D

MEDIDAS EN mm. / MEASURES IN mm.							
A	B	C	D	E	F	G	H
20	13	3,2	25,4	44,5	14,4	9,0	3,5

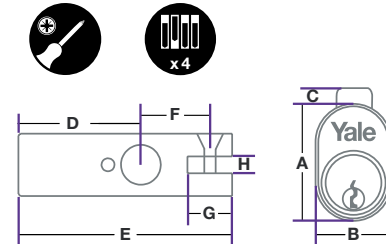

Serie 560 / 560 series

- Para vitrinas y puertas corredizas
 - 4 pines
 - Cobertura en caucho antideslizante
 - 2 llaves
- For glass cabinets and sliding doors
 - 4 pins
 - Anti-sliding rubber coverage
 - 2 keys

MEDIDAS EN mm. / MEASURES IN mm.					SKU	DESCRIPCIÓN / DESCRIPTION
A	B	C	D	E		
121,7	32,8	111,6	26,3	23,6	0001574	Mueble 560 US26D

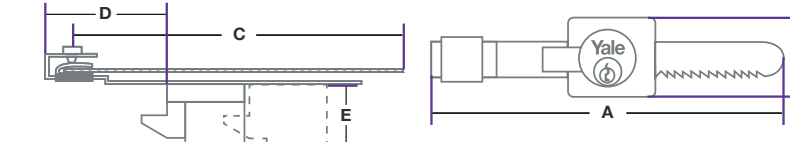

Serie 540 / 540 series

- Cerrojo de gancho para puertas corredizas
 - 4 pines
 - Cilindro en latón
 - 2 llaves
- Deadbolt lock for sliding doors
 - 4 pins
 - Brass cylinder
 - 2 keys

SKU	DESCRIPCIÓN / DESCRIPTION
0010591	Mueble 540 US26D I
0010589	Mueble 540 US26D D

MEDIDAS EN mm. / MEASURES IN mm.					
A	B	C	D	E	F
20,2	16,3	33,0	49,6	22,2	23,9

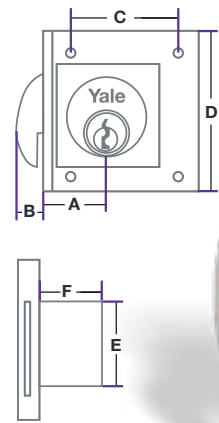
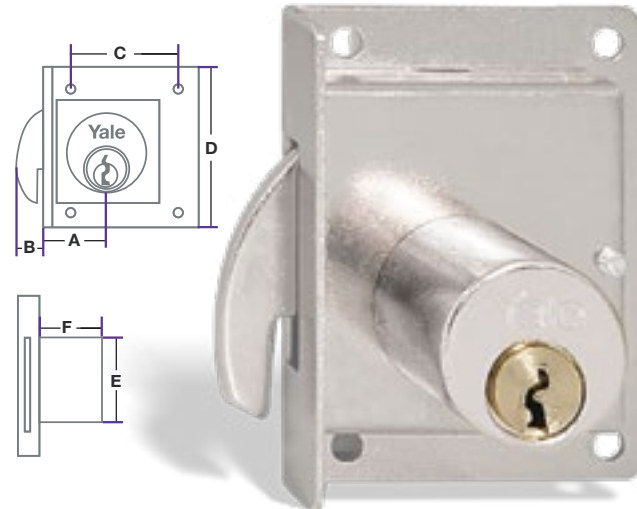

LÍNEA ESTÁNDAR
Standard line

Una línea creada para guardar sus objetos cotidianos / A line created to keep your everyday objects



Serie B410 / B410 series

- Cerrojo de acción vertical
 - 2 llaves
- Vertical action bolt
 - 2 keys

SKU	DESCRIPCIÓN / DESCRIPTION
0005157	Mueble estandar B410 US26D



Serie 555B / 555B series

- Cuerpo hecho de latón
 - 4 pines
 - Backset 20mm
 - Para armarios y muebles
 - 2 llaves
- Brass plated body
 - 4 pins
 - 20mm backset.
 - For cabinets and furniture
 - 2 keys

SKU	DESCRIPCIÓN / DESCRIPTION
0005151	Mueble 555B US3

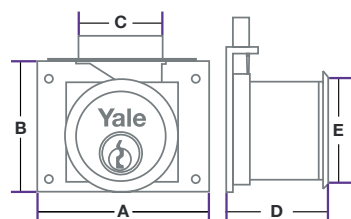

MEDIDAS EN mm. / MEASURES IN mm.				
A	B	C	D	E
51,0	38,0	21,4	23,4	22,1

Serie B420 / B420 series

- Cerrojo de acción vertical
 - 2 llaves
- Vertical action bolt
 - 2 keys

SKU	DESCRIPCIÓN / DESCRIPTION
0005019	Mueble estandar B420 US26D





Serie B430 / B430 series

- Para puertas dobles batientes
 - La misma cerradura bloquea ambas puertas
 - 2 llaves
- For double swinging doors
 - The lock blocks both doors
 - 2 keys



SKU	DESCRIPCIÓN / DESCRIPTION
0005027	Mueble estandar B430 US26D

Serie B440 / B440 series

- Cerrojo tipo gancho de acción giratoria
 - 2 llaves
- Rotating action hook bolt
 - 2 keys



SKU	DESCRIPCIÓN / DESCRIPTION
0005030	Mueble estandar B440 US26D



Serie B450 / B450 series

- Cerrojo tipo botón, cierra al presionar sin llave
 - 2 llaves
- Deadbolt lock with button, locks when pressed without key
 - 2 keys



Sku	Descripción / description
0005029	Mueble estandar B450 US26D

Serie B460 / B460 series

- Cerrojo de acción vertical
 - Para puertas de vidrio batientes
 - 2 llaves
- Vertical action bolt
 - For swinging glass doors
 - 2 keys

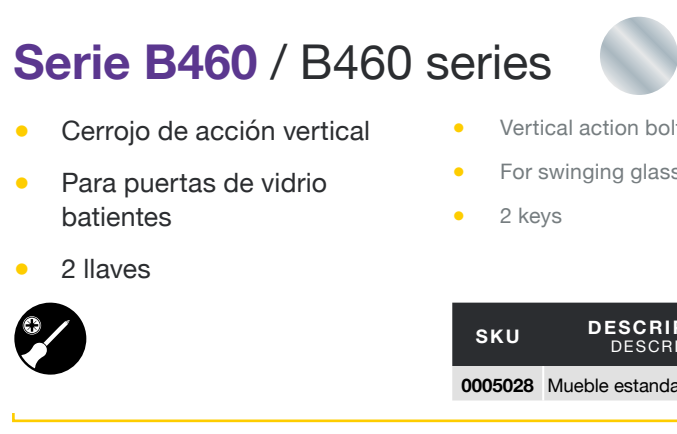

SKU	DESCRIPCIÓN / DESCRIPTION
0005028	Mueble estandar B460 US26D



Ref: Tope puertas magnético T10



ACCESORIOS
Accessories



Los accesorios de Yale son el complemento perfecto para puertas institucionales y residenciales.

Estos productos permiten que el tránsito por las puertas sea más ágil manteniendo una apariencia arquitectónica.

Yale accessories are the perfect complement for commercial and residential doors.

These products allow easy operation of high traffic doors while maintaining an architectural design appearance.

GLOSARIO

Glossary

Acabados / Finishes:



AI
Acero inoxidable
/ Stainless steel

Abreviatura / Abbreviation:

AI: Acero inoxidable
/ Stainless steel

Características / Features:



Instalación sencilla
Easy installation

TOPE PUERTAS

Door stopper

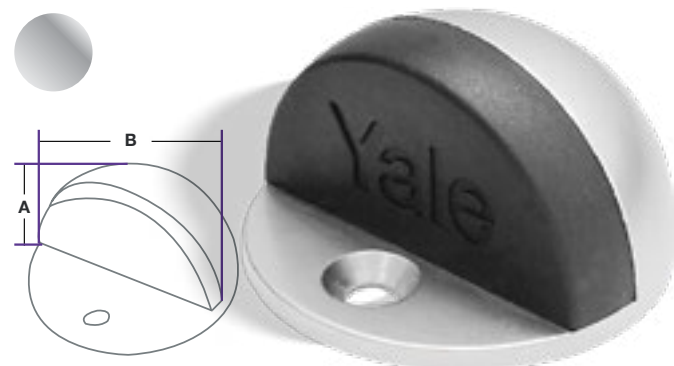

Tope puerta / Door stopper

- Cuerpo en zamac
- Garantía por 1 año
- Zamac body
- 1 year of guarantee



SKU	DESCRIPCIÓN / DESCRIPTION
0010531	Tope puerta

MEDIDAS EN mm. / MEASURES IN mm.	
A	B
25	45



Tope puertas magnético T10 / T10 Magnetic door Stopper

- Para instalación en piso
- Doble función: evitar golpes contra pared y mantener la puerta abierta aún con corrientes de aire
- Fácil instalación
- Floor installation
- Double function: Avoid hits against the wall and keep the door open even in windy conditions
- Easy to install

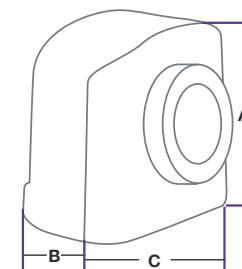

MEDIDAS EN mm. / MEASURES IN mm.		
A	B	C
38	31	45

SKU	DESCRIPCIÓN / DESCRIPTION
0009141	Tope Puerta Magnetic T10

Tope puertas magnético T11 / T11 Magnetic door Stopper

- Para instalación en puerta o pared
- Doble función: evitar golpes contra pared y mantener la puerta abierta aún con corrientes de aire
- Fácil instalación
- Door or wall installation
- Double function: Avoid hits against the wall and keep the door open even in windy conditions
- Easy to install



MEDIDAS EN mm. / MEASURES IN mm.	
A	B
76	44

SKU	DESCRIPCIÓN / DESCRIPTION
0009142	Tope Puerta Magnetic T11



Diseño y calidad
para sus espacios

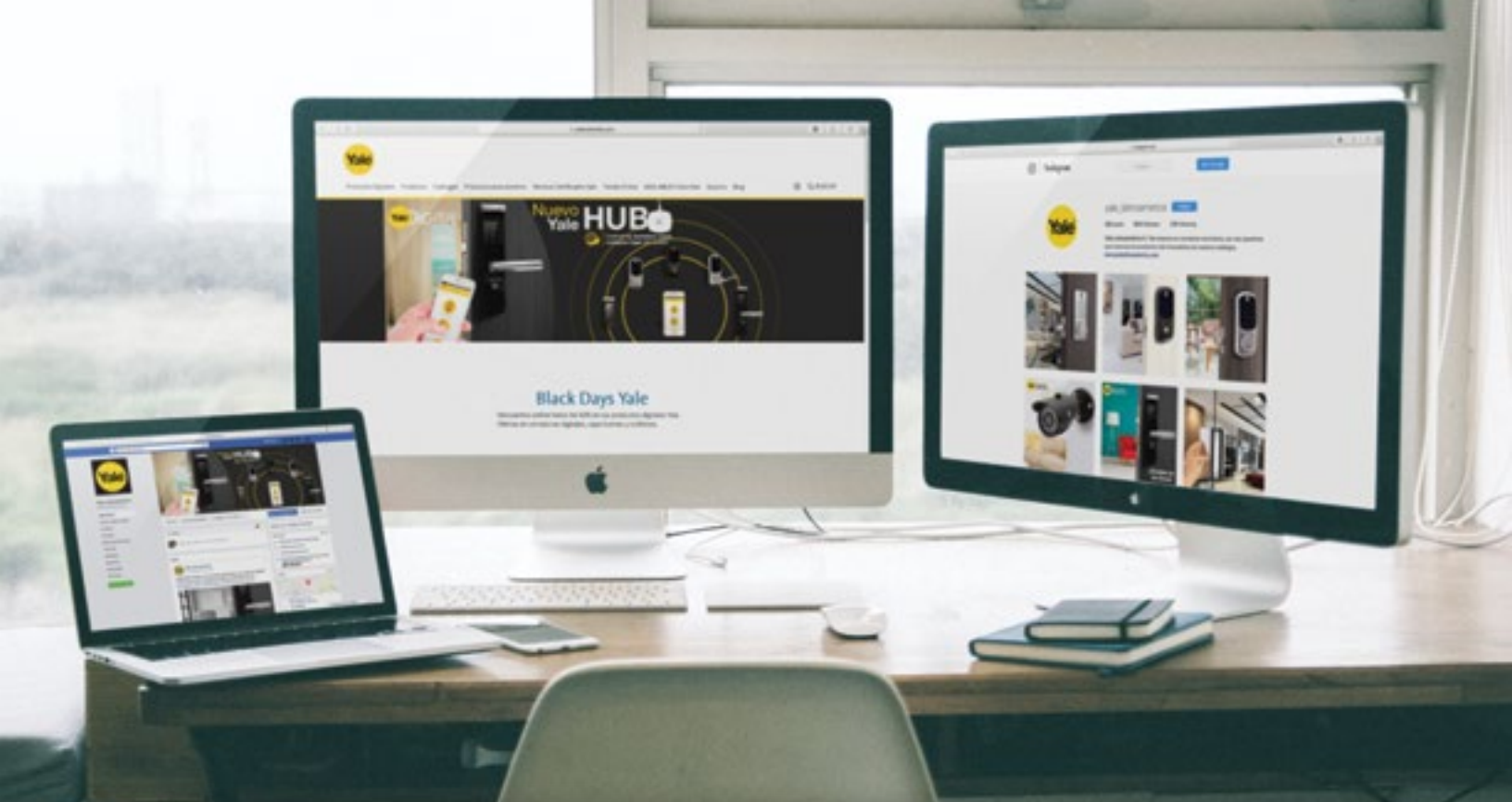

ESTAMOS **AQUÍ** PARA
AYUDARLE

SÍGANOS EN NUESTRAS REDES



+57 318 365 9422



/YaleLatinoamerica



@Yale_Latinoamerica



/YaleLatinamerica

www.yalecolombia.com